

SIGMA DP2

THE SIGMA DP2
A FULL SPEC COMPACT
DIGITAL CAMERA WITH ALL
THE POWER OF DSLR

USER'S MANUAL

This manual explains how to use the **SIGMA DP2** digital camera. Please refer to the **SIGMA Photo Pro** User Guide, which is available in the PDF format of the supplied CD-ROM, to get information about installation of **SIGMA Photo Pro** software to your computer, connection between camera and computer and for detailed explanation

Thank you for purchasing the Sigma DP2 Digital Compact Camera

You will get the greatest performance and enjoyment from your new DP2 camera's features by reading this instruction manual carefully before operating it. Enjoy your new Sigma camera!

- Please keep this instruction booklet handy for future reference. Doing so will allow you to understand and take advantage of the camera's unique features at any time.
- The warranty of this product is one year from the date of purchase. Warranty terms and warranty card are on a separate sheet, attached. Please refer to these materials for details.

NOTES ON COPYRIGHT

This camera is intended only for personal use and should never be used in a way that infringes upon or contravenes international or domestic copyright laws and regulations. In addition, although it is intended purely for personal use, some restrictions may be applied to the photographing of demonstrations, performances, shows, exhibitions, or commercial properties, etc. Copyright or other legal rights should not be contravened.

- FOVEON is a registered trademark of Foveon, Inc. X3, and the X3 Logos are trademarks of Foveon, Inc.
- IBM PC/AT series computer is a trademark or registered trademark of International Business Machines Corporation (IBM) in the U.S.A.
- Microsoft and Windows are either registered trademarks or trademarks of Microsoft Corporation in the United States and/or other countries.
- Macintosh and MAC OS are registered trademarks or trademarks of Apple Inc. in the U.S.A. and /or other countries.
- Adobe and Photoshop are trademarks of Adobe Systems Incorporated.
- All other company or product names used in documents are trademarks or registered trademarks of their respective holders.
- Ricoh True Type Font designed by Ricoh CO., Ltd. is used for the display of the menu window of this camera.



Disposal of Electric and Electronic Equipment in Private Households
Disposal of used Electrical & Electronic Equipment (Applicable in the European Union and other European countries with separate collection systems)

This symbol indicates that this product shall not be treated as household waste. Instead it shall be collected separately for the recycling of electrical and electronic equipment.

If the new products are purchased, this product might be handed over to the distributor or the collection system of waste electrical and electronic equipment eventually.

By ensuring this product is disposed of correctly, you will help prevent potential negative consequences for the environment and human health, which could otherwise be caused by inappropriate waste handling of this product or components of this product.

If this product is disposed illegally, it might cause a possibility of penalties.

For more detailed information about recycling of this product, please contact your local city office, your household waste disposal service or the shop where you have purchased the product.

PACKAGE CONTENTS / ACCESSORIES

Please make sure that following standard accessories are included with your camera. If any of them is missing, contact the retailer from which you purchased your camera immediately.

1. Camera Body (DP2)
2. Lens Cap (on the camera)
3. Hot Shoe Cover (on the camera)
4. Soft Case
5. Strap
6. Li-ion Battery BP-31
7. Battery Charger BC-31
8. Battery Charger Cable
9. USB Cable
10. Audio Video Cable
11. SIGMA Photo Pro Disc
12. Instruction Manual
13. Warranty Card
14. SIGMA Limited Warranty & Service Network

- No memory card is included with this camera. Please purchase this separately.

TABLE OF CONTENTS

PACKAGE CONTENTS / ACCESSORIES.....	2
TABLE OF CONTENTS.....	3
SAFETY PRECAUTIONS	6
HANDLING PRECAUTIONS.....	9
DESCRIPTION OF THE PARTS	11
COLOR LCD MONITOR INDICATION.....	13
BASIC OPERATION AND QUICK REFERENCE	14
PREPARATION	17
ATTACHING THE CARRY STRAP	17
LENS CAP	18
LOADING THE BATTERY.....	19
CHECKING THE BATTERY STATUS	22
USING A HOME POWER SUPPLY (SOLD SEPARATELY)	23
SETTING THE LANGUAGE.....	24
SETTING THE TIME AND DATE	25
CAMERA SET-UP MENU.....	26
LIST OF MENU FUNCTIONS	29
QUICK SET MENU.....	34
CHANGING THE COLOR LCD MONITOR DISPLAY.....	35
INSERTING AND REMOVING THE CARD	37
FORMATTING THE CARD.....	39
SHUTTER BUTTON.....	39
RESET TO THE DEFAULTS	40
BASIC OPERATION	41
SELECTING THE EXPOSURE MODE	41
P PROGRAM AE	41
A APERTURE PRIORITY AE	43
S SHUTTER SPEED PRIORITY AE	44
M MANUAL EXPOSURE.....	45
USING THE BUILT-IN FLASH	46
USING THE BUILT-IN FLASH.....	46
FOCUSING	48
HOW TO USE AUTOFOCUS	48
FOCUSING POINT SELECTION	49





FOCUS LOCK	49
MANUAL FOCUS	50
OPERATION OF THE DRIVE MODE	51
SINGLE FRAME SHOOTING	51
CONTINUOUS SHOOTING	52
SELF TIMER	52
ADVANCED OPERATION	53
SETTING THE WHITE BALANCE (WB)	53
SETTING THE SENSITIVITY (ISO EQUIVALENCY)	56
IMAGE FILE SETTING.....	57
COLOR SPACE	58
PICTURE SETTINGS.....	59
SELECTING THE METERING MODE	60
AE LOCK	61
EXPOSURE COMPENSATION	63
FLASH EXPOSURE COMPENSATION	64
AUTO BRACKETING	65
COLOR MODE	67
IMAGE WITH SOUND.....	68
USING THE EXTERNAL FLASH	69
AUTO ROTATE.....	70
INTERVAL TIMER	71
MY SETTINGS	73
EXP. KEY ARRANGEMENT	74
REVIEWING AND DELETING IMAGES	75
QUICK PREVIEW	75
CHANGING THE QUICK PREVIEW DURATION	75
REVIEWING IMAGES	76
VIEWING ONE IMAGE AT A TIME.....	77
MAGNIFYING IMAGES (ZOOMED-IN VIEW).....	78
VIEWING NINE IMAGES AT A TIME (CONTACT SHEET VIEW).....	79
VIEWING IMAGES A PAGE AT A TIME (JUMP MODE)	80
VIEWING IMAGES WITH SOUND.....	81
VIEWING IMAGE INFORMATION	82
HISTOGRAM.....	84

VIEWING IMAGES ON A TV	85
DELETING FILES	86
DELETING A SINGLE FILE.....	87
DELETING MULTIPLE FILES	88
OTHER REVIEWING FEATURES	89
LOCKING FILES	89
MARKING IMAGES.....	92
ROTATING IMAGES	95
EXPOSURE WARNING	96
OK BUTTON SHORTCUT.....	96
RECORDING SOUND MEMO	97
SHOWING A SLIDESHOW	99
RECORDING AND PLAYING BACK MOVIES	101
RECORDING MOVIES	101
PLAYING BACK MOVIES	102
RECORDING AND PLAYING BACK SOUND	104
RECORDING SOUND (VOICE RECORD MODE)	104
PLAYING BACK SOUND	105
PRINTING IMAGES	106
PRINTING IMAGES WITH PICTBRIDGE COMPATIBLE PRINTERS	106
DPOF (DIGITAL PRINT ORDER FORMAT).....	109
REFERENCE	110
OPTIONAL ACCESSORIES.....	110
MAINTENANCE	110
EXPLANATION OF TERMS	111
FILE NUMBERING SYSTEM	113
LCD SLEEP AND AUTO POWER OFF.....	114
TROUBLESHOOTING	115
SPECIFICATIONS.....	117
CONNECTING YOUR CAMERA TO A COMPUTER	118











SAFETY PRECAUTIONS

To avoid causing damage or injury, please read this instruction manual carefully, before using the camera.







Please take special note of the following two cautionary symbols.

-  **Warning !!** Using the product and disregarding this warning sign may cause serious injury or other dangerous results.
-  **Caution !!** Using the product disregarding this caution sign may cause injury or damage.
-  This symbol denotes a warning or point, where caution is required.
-  This Symbol contains information regarding the actions that must be avoided.









WARNING (BATTERY, BATTERY CHARGER AND AC ADAPTER)

-  Keep batteries in a safe place out of children's reach. If a battery is swallowed, call for emergency medical aid immediately.
-  Do not use any battery other than the designated battery types. Doing so may cause battery explosion, battery leakage, camera damage, injury or fire.
-  Do not use any battery other than that specified in this booklet. Otherwise, it might cause battery explosion, battery leakage, camera damage, injury or fire.
-  Avoid any shock, shake and drop. Ignoring this warning may cause battery explosion, or battery leakage, resulting in injury or fire.
-  Never disassemble, short circuit, heat, or put batteries into fire. Ignoring this warning may cause battery explosion, battery leakage, injury or fire.
-  Please only use charger with the dedicated battery. Charging other battery types causes battery explosion, battery leakage, camera damage, injury or fire.
-  If for some reason, the camera or batteries emit smoke, or if overheating or the smell of burning is detected, remove the batteries, taking care to avoid being burned. Take the camera to the retailer where you bought it, or to an authorized Sigma service station.
-  Please follow all guidelines, rules and regulations of your community regarding the disposal of batteries.
-  If you do not use the camera for a long period of time, remove the battery.
-  Do not use any AC adapter other than the one provided with your camera. Using other brands may cause electrical shock and fire

SAFETY PRECAUTIONS



-  The AC Adapter is designed for use with this product only. Do not use it with any other appliance. Doing so may cause overheating, fire, electric shock or injury.
-  If the adapter is emitting smoke, generating a strange odor or making an abnormal noise, while in use, disconnect the power plug from the outlet immediately. Otherwise, fire or electric shock may result.
-  If water or a foreign object gets into the adapter, unplug from the AC outlet immediately. It could cause fire or electric shock.
-  Do not attempt to modify or disassemble this product. Doing so can cause fire or electric shock.
-  Do not place any heavy objects on the power cord, or pull it, bend it unduly, or heat it. It could damage the cord, and could cause fire or electric shock.
-  Do not use this product with AC voltage other than the specified power supply voltage (AC100V - 240V). Doing so could cause fire or electric shock.
-  Use a safety approved AC power cord as is specified by each country.

WARNING (CAMERA)





-  Never use your camera in an environment where flammable or burnable, gas, liquids or chemicals, such as Propane, Gasoline, etc., are present.
-  Keep the camera in a safe place that children cannot reach. Playing with the camera strap around one's neck can cause strangulation.
-  Do not disassemble the camera; Doing so can cause electric shocks and burns.
-  Do not touch internal parts of the camera that become exposed as a result of damage, it could cause fire or electric shock. Remove the batteries and contact an authorized Sigma service station.
-  Keep the camera away from moisture or water. If you drop your camera/lens in water, please contact the retailer where you purchased the camera, or a service station immediately. If you use the camera with this condition it can cause electric shock or fire.
-  Prevent water, or metallic and other conductive objects from coming into contact with the terminals of the camera body. This can result in electric shock, overheating and fire.
-  Do not fire the flash close to eyes, otherwise the bright light could damage the eye. Keep at least 1m/3feet distance between the face and the camera when taking a picture with flash.
-  Do not cover the flash with your finger or hand, it can cause skin burn.

SAFETY PRECAUTIONS

CAUTION (BATTERY CHARGER AND AC ADAPTER)

-  Do not pull the Battery Charger or the AC power cord, when disconnecting the AC adapter from the AC outlet. It could cause fire or electric shock due to damaged cord. Always take hold of the molded AC plug, when unplugging it from the outlet.
-  Do not cover the Battery Charger or the AC adapter with cloth, cushions, etc. It could cause excessive heat, deform the case, and cause fire.
-  When Battery Charger is not used unplug it from the outlet.

CAUTION (CAMERA)

-  Do not leave the camera without the lens cap in place. Light entering through the lens for long periods of time could cause damage to the camera.
-  Please do not carry your camera while a tripod is attached, as this could result in injury or a fall.
-  Please do not grasp the camera with wet hand, as it might cause electric shock
-  Do not leave the camera in a hot place or in a car parked in the sun. If the camera becomes hot, it might cause burns to the skin.
-  If the liquid crystal display (LCD) monitor becomes damaged, be careful of the fragments of glass, which can cause injury. If the liquid inside the LCD monitor leaks out, and you are faced with the following situations, please do as follows.
 - If the liquid adheres to clothes or the skin, wash it away with soap immediately.
 - If the liquid enters the eye, flush the affected eye with clean water immediately for 15 minutes, and seek medical assistance.
 - If the liquid is swallowed, drink a large quantity of water, induce vomiting and seek medical assistance.

HANDLING PRECAUTIONS

Please read this section before using the camera.

Study and familiarize yourself with the functions of your camera before using it. No compensation or guarantee is provided for unsatisfactory pictures or loss of profit, etc.

Carry spare batteries when you use the camera in a cold environment, on a field trip, or when taking many pictures at one time.

ENVIRONMENT

- Your camera is a precision instrument. Do not drop it or subject it to physical shock.
- This camera is not waterproof, and cannot be used underwater. Wipe off any water droplets with a dry cloth as soon as possible. If the camera gets really wet, promptly consult your nearest Sigma Service Center.
- Do not leave the camera in a dusty, hot, or highly humid environment for a long period of time.
- If the camera is moved from a cold place to a warm room, water droplets may appear on the camera. Please keep the camera in a bag until it is acclimatized to the ambient room temperature.
- The camera will work within a temperature range between 0°C/32°F and +40°C/104°F and humidity less than 80% (no condensation). However, in cold temperatures below 0°C, the power performance of the battery is reduced. Please carry a spare battery in these circumstances, and keep the batteries warm.
- Static electricity or magnetic fields, may effect the operation of the camera. If such exposure occurs, please remove the battery from the camera and re-insert it, to reset the camera's microprocessors.

HOW TO STORE THE CAMERA

- If you intend to store the camera for a long time, remove the battery.
- To avoid growth of fungus, store the camera and lens in a dry, cool and ventilated place, with a drying agent such as silica gel. Keep your equipment away from chemicals.

NOTE ON THE TFT COLOR LCD MONITOR

- A few pixels may always be lit or may never light on the LCD monitor. This is not a failure or malfunction. Images recorded with the camera will not be affected.
- Because of the normal physical characteristics of the liquid crystal, the reaction of the display may become slow at low temperatures. At high temperatures, the display may become dark, but it will return to normal at room temperature.

SD MEMORY CARD AND MULTIMEDIA CARD (SOLD SEPARATELY)

The DP2 camera uses a SD memory card, SDHC memory card and multimedia card.

- In this instruction manual, SD memory card, SDHC memory card and Multimedia card are referred to as the 'Card'.
- We recommend SDHC memory card or high speed SD memory card to store images.
- SD memory card or SDHC memory card incorporate the write protection switch, which prevents writing or formatting the card accidentally. If the switch is placed in the 'LOCK' position, it is not possible to overwrite or erase your data accidentally.

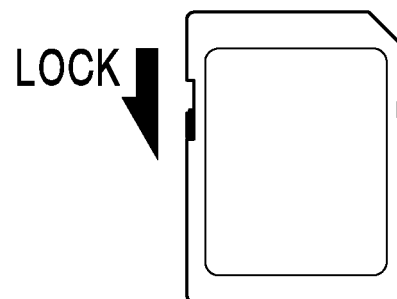





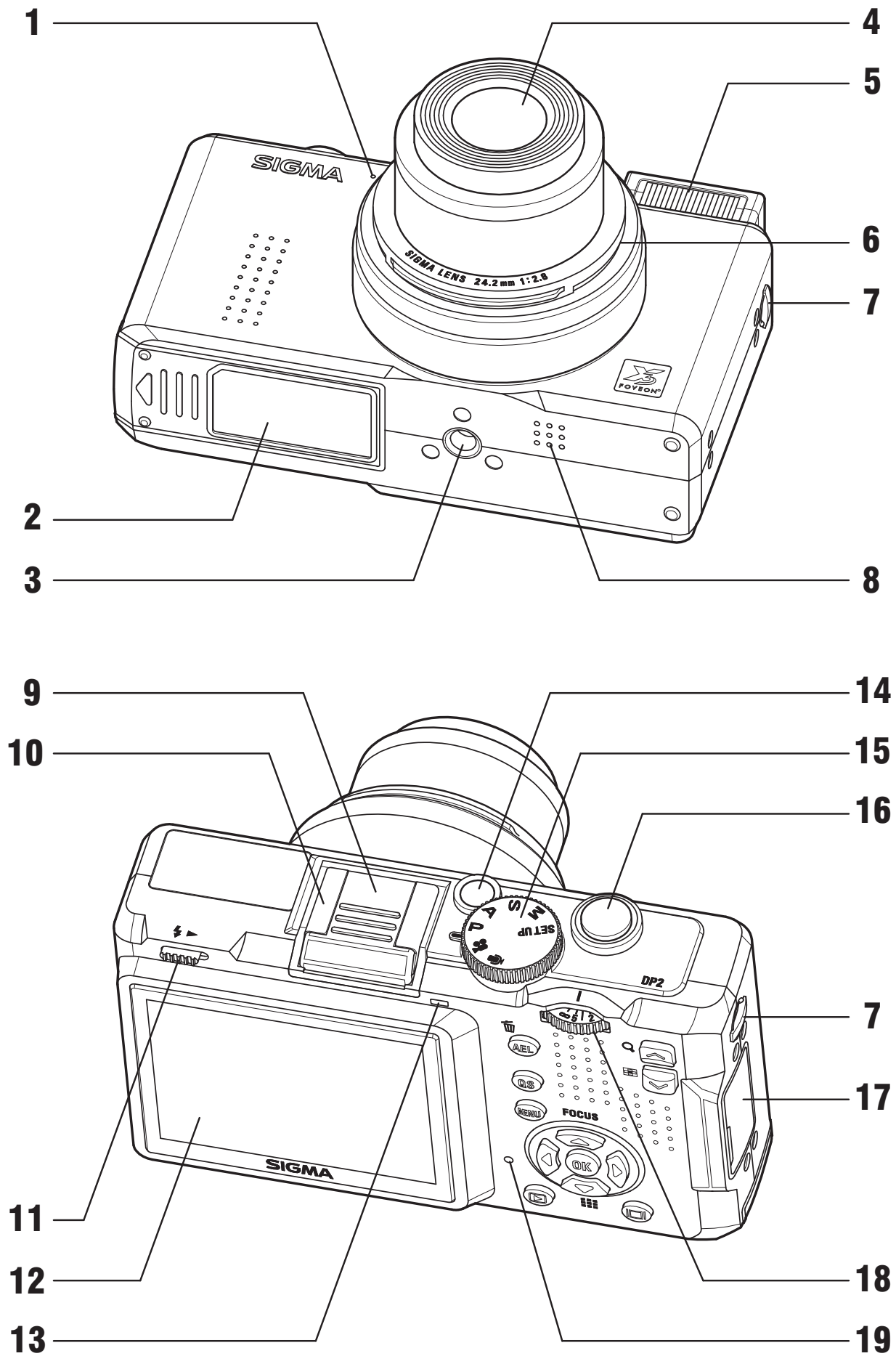

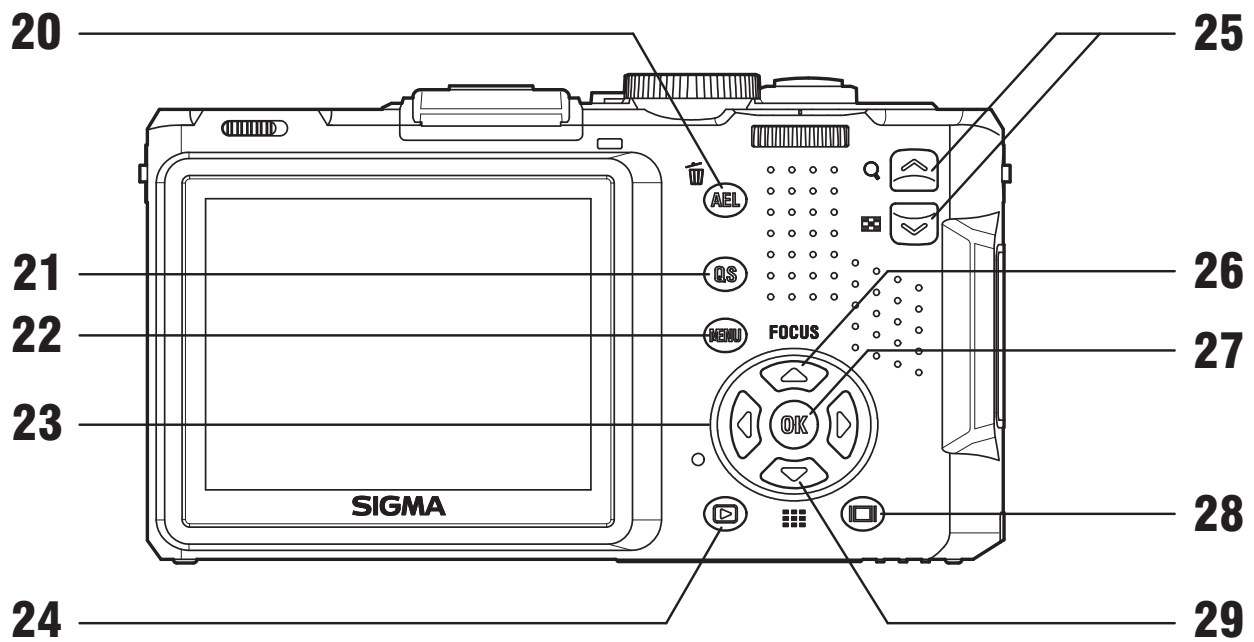

- We do not recommend using a multimedia card in continuous shooting or Movie mode due to the slow writing speed.
- Do not leave the card in direct sunlight or near a heating device.
- Avoid storing cards in environments of high temperature and humidity or where static electricity or electromagnetic fields may be generated
- For proper usage of the card, please refer to their instruction manuals.
- The "Delete" feature of the Camera and PC may not delete the data in the memory card completely. Some data might still remain. If you wish to remove all data from card securely, please use third party software.

DESCRIPTION OF THE PARTS





1.	MICROPHONE
2.	BATTERY / CARD COVER
3.	TRIPOD SOCKET
4.	LENS
5.	FLASH
6.	LENS CAP MOUNT
7.	CAMERA STRAP EYELET
8.	SPEAKER
9.	HOT SHOE COVER
10.	HOT SHOE
11.	FLASH POP-UP LEVER
12.	COLOR LCD MONITOR
13.	AUTO FOCUS LAMP
14.	POWER SWITCH
15.	MODE DIAL
16.	SHUTTER BUTTON
17.	CONNECTOR COVER
18.	MF DIAL
19.	BUSY LAMP

20.	AEL /  (AE LOCK / DELETE) BUTTON
21.	QS (QUICK SET) BUTTON
22.	MENU (MENU) BUTTON
23.	 4-WAY CONTROLLER
24.	 (VIEW) BUTTON
25.	 BUTTON  BUTTON
26.	FOCUS (FOCUS MODE) BUTTON
27.	 (OK) BUTTON
28.	 (DISPLAY) BUTTON
29.	 (FOCUSING POINT) BUTTON

COLOR LCD MONITOR INDICATION

Explanation of the icons displayed in still image shooting.

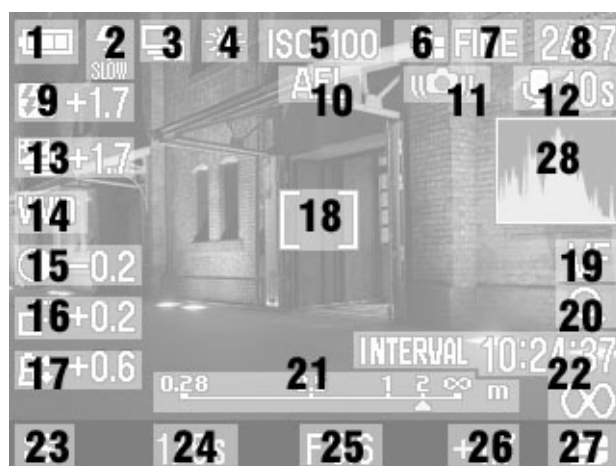

1	Battery Level Indicator
2	Flash Mode *
3	Drive Mode *
4	White Balance *
5	ISO Sensitivity
6	Image Size
7	Image Quality
8	Number of shots remaining
9	Flash Exposure Compensation value *
10	AE Lock *
11	Camera Shake Warning
12	Image With Sound *
13	Auto Bracket *
14	Color Mode

15	Contrast *
16	Sharpness *
17	Saturation *
18	Focusing Frame
19	Focus Mode *
20	MF Enlarged Display *
21	MF Scale Bar *
22	Interval timer *
23	Exposure Mode
24	Shutter Speed
25	F Number
26	Exposure Compensation Value / Exposure Meter
27	Metering Mode
28	Histogram *

* Displayed only during setting.

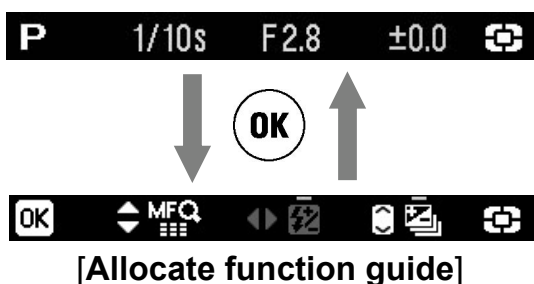

During the Shooting Mode, it is possible to change the exposure indicator at the bottom of the display to the Allocate function guide by pressing the **OK** button. It is possible to confirm the current allocated function by pressing the **◀▶** button and the **⏏** button.



This mark shows that the image is being processed in camera after shooting. While this mark is displayed, it is not possible to operate the camera.

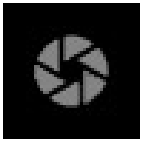

This mark shows that the camera is still shooting with a slow shutter speed.

BASIC OPERATION AND QUICK REFERENCE

The DP2 camera has many advanced features. This section, describes basic camera operation. You can find more details in later sections.

PREPARATION

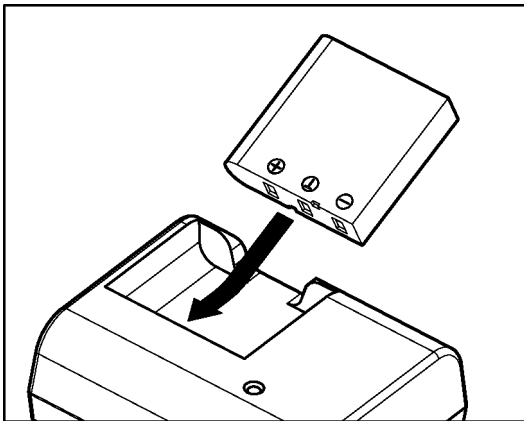

Charging the battery (P.19)

Charge the supplied lithium-ion battery with the provided battery charger.

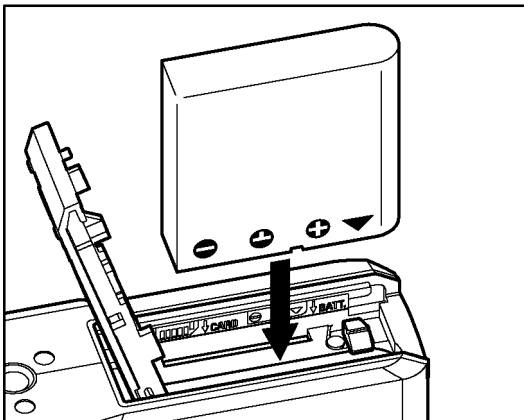

To insert the battery (P.20)

Insert the battery into the chamber in accordance with the diagram.

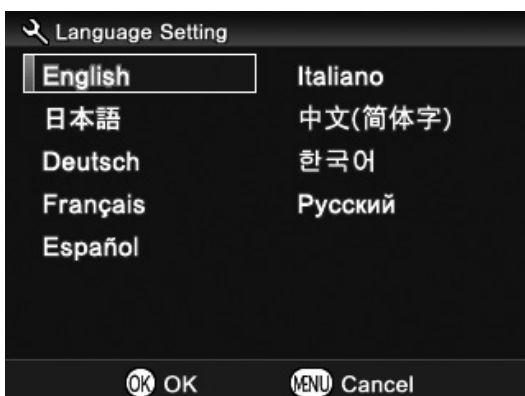

Set the language (P.24)

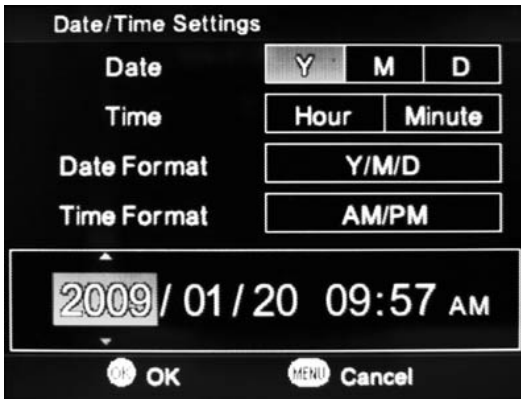

Set the date and time (P.25)

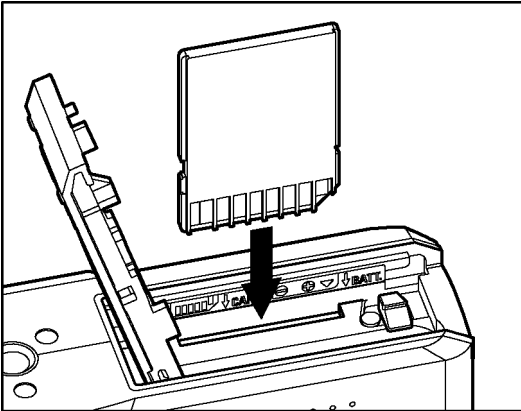

Loading the card (P.37)

TAKING THE PICTURE

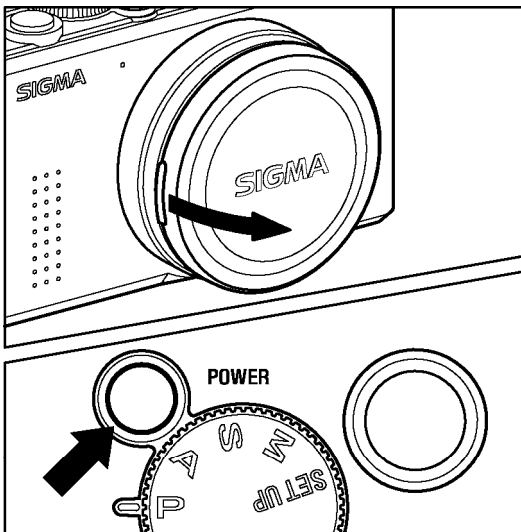

Turn the camera body on.

Remove the lens cap and press the Power switch.

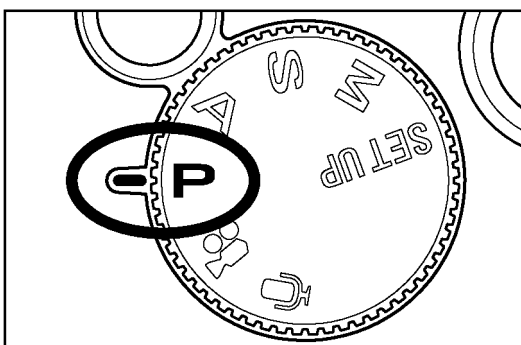

Select the exposure mode (P.41)

Put the 'Mode' dial switch in **P** (Program AE) position



Focus (P.48)

Compose your image with the color LCD monitor and press the shutter button “half-way” to activate exposure metering and autofocus.

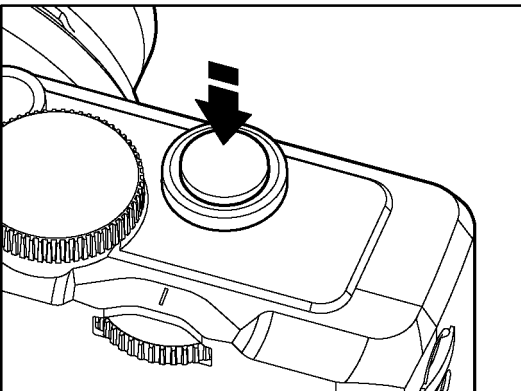
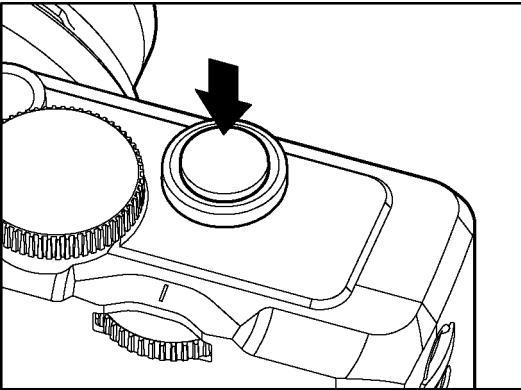

Take a picture

Fully press the shutter button to take the picture.



Review the image. (P.75)

The image is displayed for 2 seconds on the LCD monitor.

PREPARATION

This section describes necessary preparations before using the camera.

ATTACHING THE CARRY STRAP

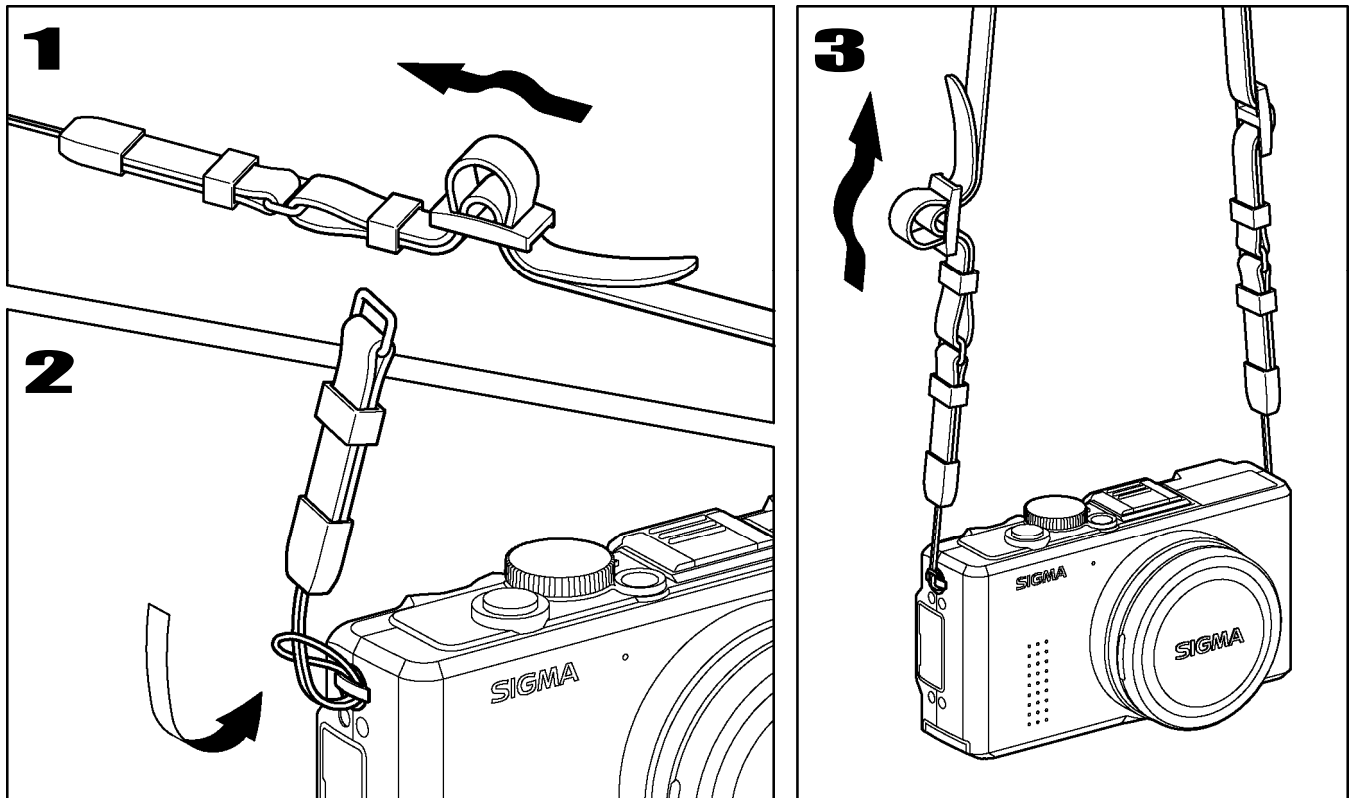

1
Undo the end of the strap.

2
Attach the camera strap to camera strap eyelet on both sides as shown.

3
Reassemble the camera strap as shown.

LENS CAP

To preserve the lens, the lens cap is attached. If you do not use the camera, please keep the lens cap attached.

HOW TO REMOVE THE LENS CAP

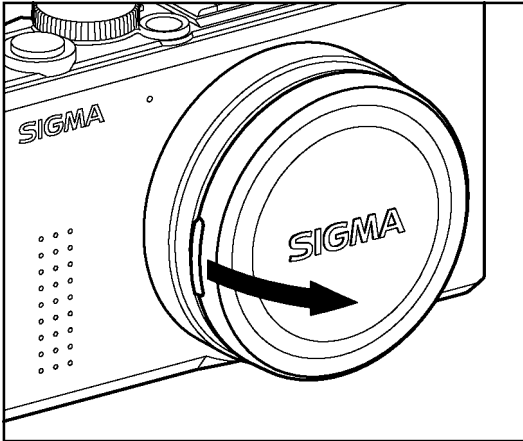

Remove the lens cap as shown.

ATTACHING THE LENS CAP

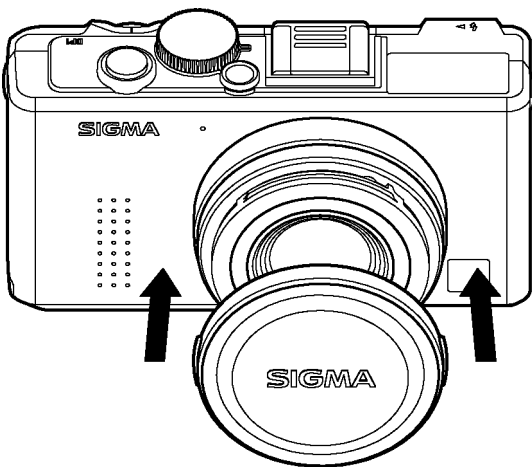

Fit the lens cap keeping the **SIGMA** logo horizontal.

CAUTION!!

- If you turn camera body on with the lens cap, the camera will stop the lens from zooming. Please remove the lens cap and then turn on once again.
- It is not possible to attach the lens cap when the lens is zoomed out. Please turn the camera off to return the lens to its original position and fit the lens cap.

LOADING THE BATTERY

A lithium-ion battery, BP-31, is provided with the DP2 camera. Charge the battery before using the camera for the first time. Charge the battery by the supplied battery charger, BC-31, when the battery is empty.

TO CHARGE THE BATTERY

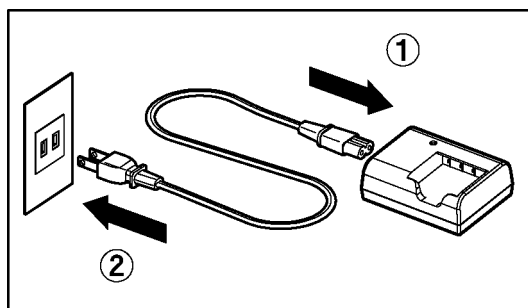

1

Connect the power cable to the charger and insert the plug into the wall outlet.

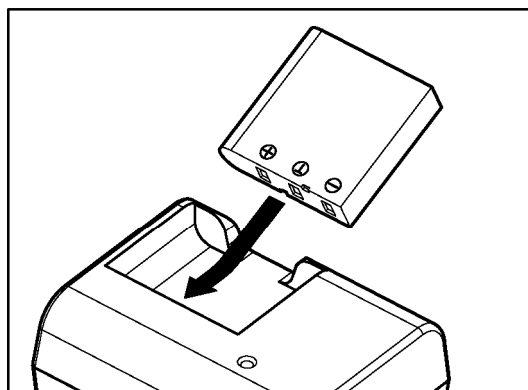

2

Attach the battery by sliding it in the direction of the arrow, as shown in the diagram.

- Charge lamp will turn red during charging.
- It takes about 120 minutes to recharge the battery.
- Required time for recharging the battery depends on the ambient temperature and status of recharge level.

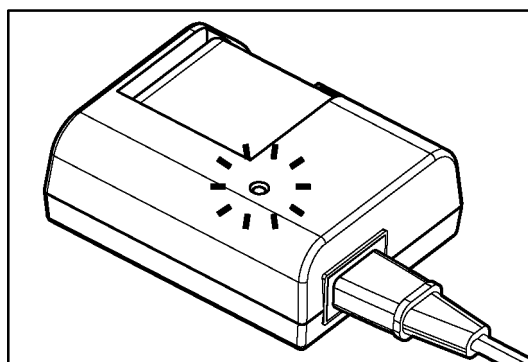

3

When the charge lamp turns green, charging is completed. Remove the battery from the charger and remove the power cable plug from the wall outlet.

- We recommend charging the battery before using the camera again. If it is not used for several days, the battery performance decreases.
- If the number of possible images from one charge of the battery considerably decreases, it may indicate the end of battery's life. In this case, please purchase a new battery.

LOADING THE BATTERY

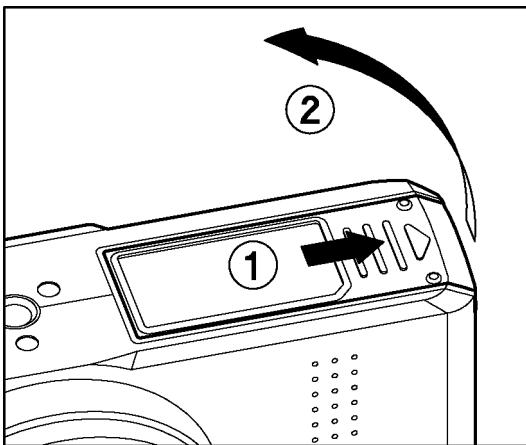

1

Open the Battery / Card Cover in the direction of the arrow, as shown in the instruction.

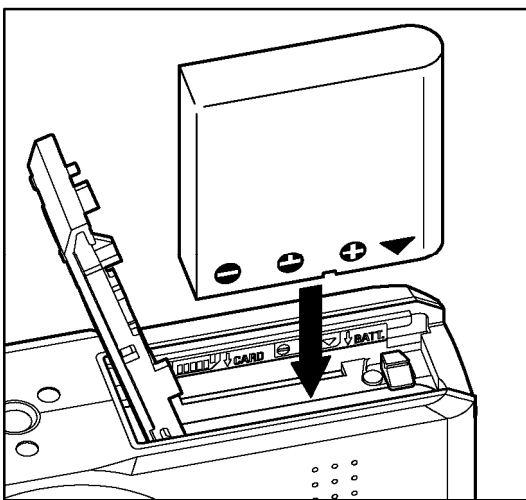

2

Insert the battery into the chamber in accordance with the diagram.

- Insert the battery until it locks into place.

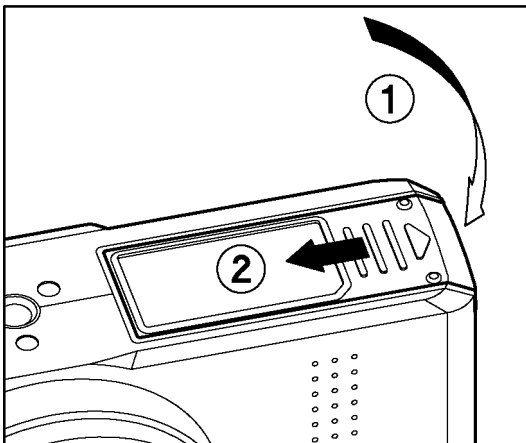

3

Close the cover securely.

- Slide the cover until it clicks into the locked position.

TO REMOVE THE BATTERY

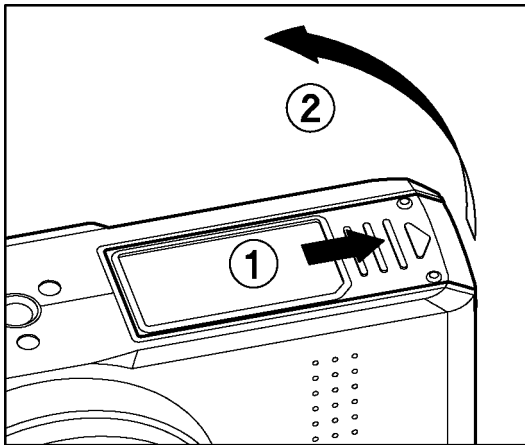

1

Make sure the camera is turned off and open the Battery / Card Cover in the direction as shown by the arrow.

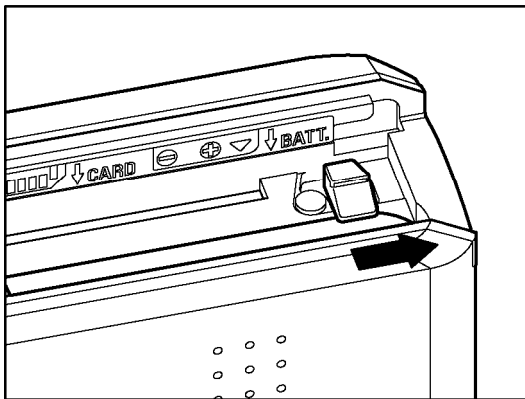

2

Eject the battery by sliding the battery compartment cover latch in the direction of the arrow, as shown in the illustration.

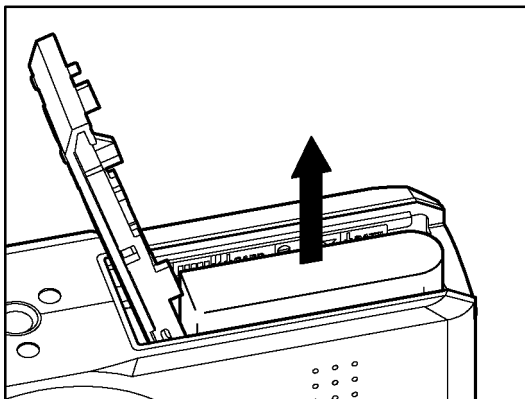

WARNING!!





- While the Busy Lamp is on, please do not remove the battery. Doing so can result in data loss. Moreover, the camera and card may be damaged.

CHECKING THE BATTERY STATUS

The battery icon, which shows the capacity of the battery, is shown on the left corner on the color LCD panel.

Explanations of the symbols are given as follows.

Please take notice of the battery status before and when in use.

	Battery Status
 White	The battery strength is sufficient.
 White	The battery level is low and the battery will need to be changed soon.
 White	The power of the battery is insufficient, replace the battery immediately.
 Red	The power of the battery is empty; it is not possible to work. Please replace the battery.

USING A HOME POWER SUPPLY (Sold Separately)

You can power the camera from a wall outlet using the provided AC Adapter - (SAC-3). When using your camera for an extended period of time, reviewing the pictures or connecting the camera to a computer or cleaning the image sensor, we recommend that you operate the camera from a household power outlet.

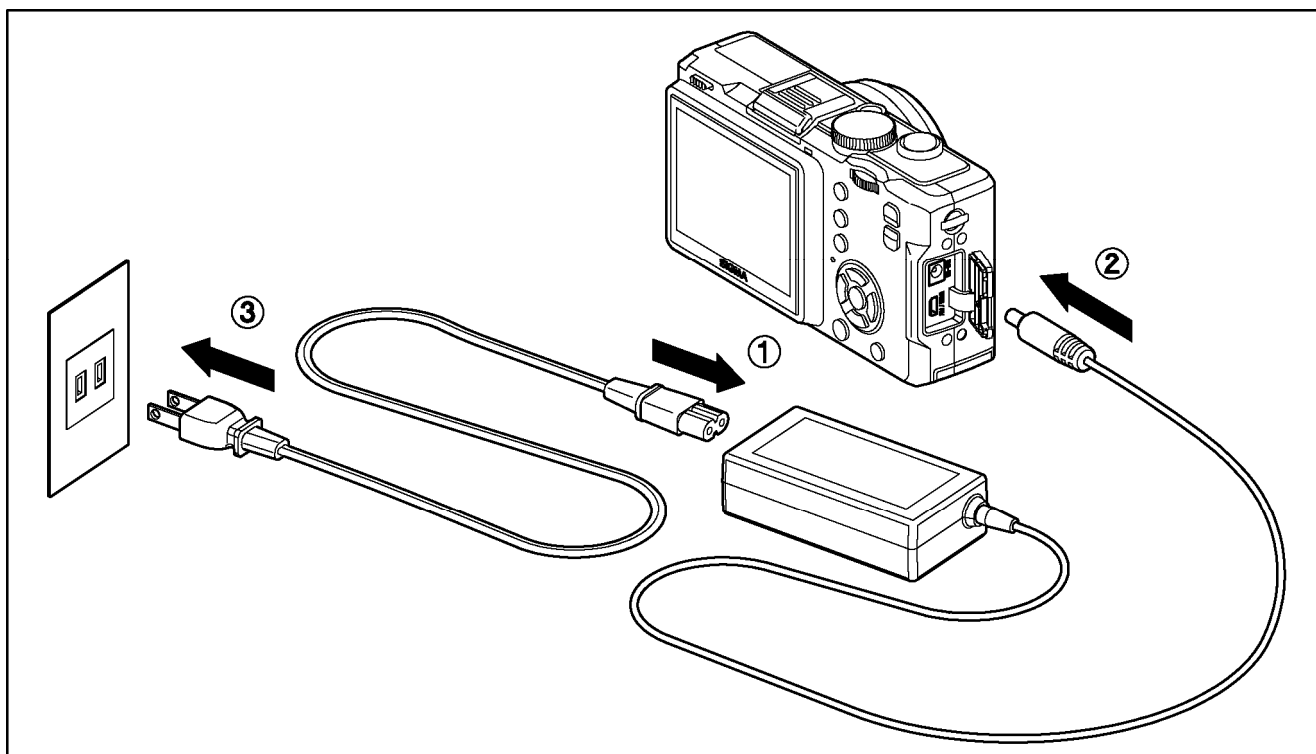

1

Connect the AC cable to the AC adapter. ①

2

Turn off the camera and connect the plug of the AC adapter to the camera. ②

3

Insert the plug of the AC cable into a wall outlet. ③

When you have finished using the camera, please turn off the camera and disconnect the plug from the wall socket.

When using the DP2 with an AC power supply, the battery icon shows the full symbol, regardless of the power level of the battery. If you start to operate the camera on battery power, the display will change and show the remaining power level of the battery.

WARNING!!

- While the Busy Lamp is on, do not change the power supply by any means. Doing so can result in data loss or damage to the camera or card.

SETTING THE LANGUAGE

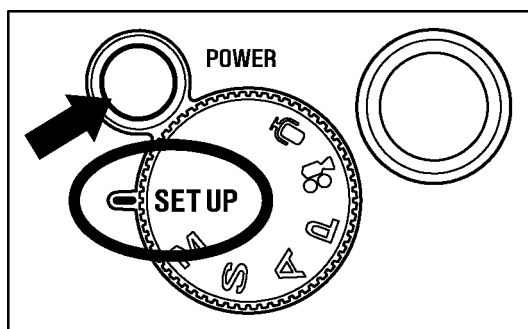

You should receive the DP2 camera pre-set to English, however, if necessary, you can change the camera language yourself.



1

Set the Mode Dial to the **SET UP** position and turn the camera on.

2

Use the  button to select the [Language (言語)] menu and press the  button.

3

When the “:Jump to Language Setting menu” message is displayed, press the  button again.

4

Use the  button to select the desired language from the following nine languages.

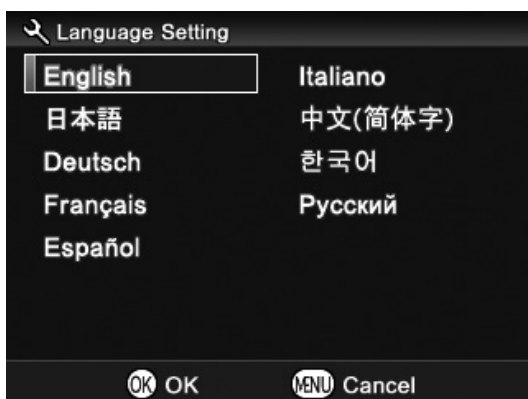

English	English
日本語	Japanese
Deutsch	German
中文(简体字)	Chinese
Français	French
Español	Spanish
Italiano	Italian
한국어	Korean
Русский	Russian

5

Press the  button to apply the setting or the **MENU** button to return to the sub-menu without making any changes.

SETTING THE TIME AND DATE

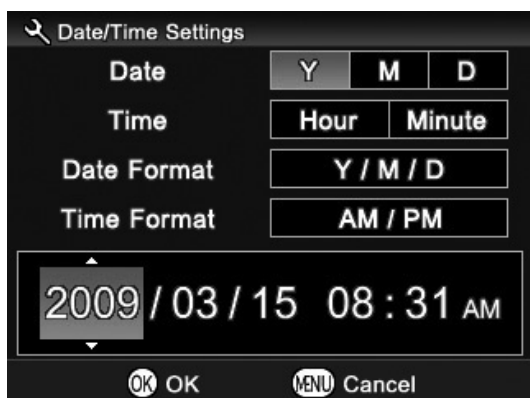
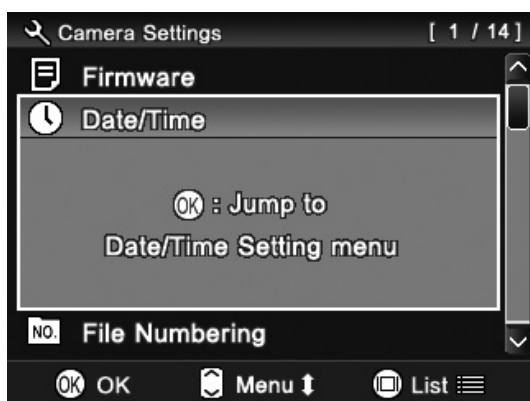
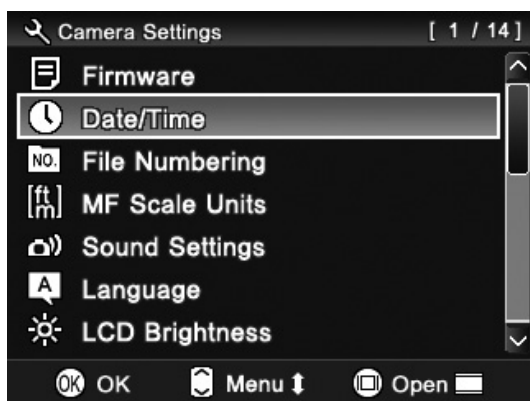



The DP2 camera records the date and time when each image is captured and stores this information with the image. To ensure that the correct information is recorded with each image, set the camera's internal clock to the correct date and time before using the camera for the first time or after extended periods of disuse.



1

Set the Mode Dial to the **SET UP** position and turn the camera on.



2

Use the  button to select the **[Date / Time]** menu and press the  button.

3

When the “ : **Jump to Date / Time Setting menu**” message is displayed, press the  button again.

4

Press the  button to select an item and change it by pressing the  button.

5

Press the  button to apply the setting or the **MENU** button to return to the sub-menu without making any changes.

TIP

- The date can be displayed in one of three formats: M/D/Y (month/day/year), D/M/Y (day/month/year), or Y/M/D (year/month/day). Select the desired format from “**Date Format**”.
- The camera's internal clock is powered by a capacitor that receives its charge from camera's battery. If the camera is without battery for an extended period of time, such as after prolonged storage, the internal clock will need to be reset.

CAMERA SET-UP MENU

This section describes the various settings in the Camera Set-up menu.

It is possible to set the camera functions or “reset settings to default” from the Camera Set-up menu display. The Camera Set-up menu is divided into three groups.

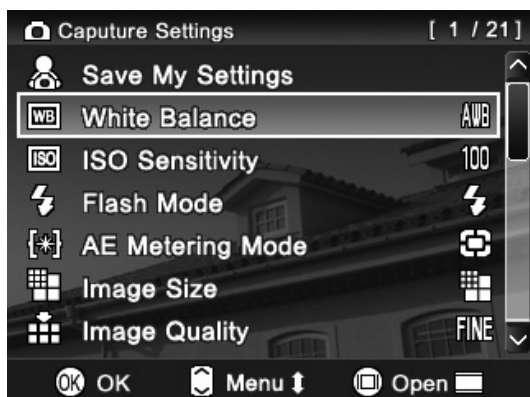

Capture Settings

This menu relates to settings of still images and movie recordings. When an exposure mode is selected and **MENU** is pressed [ **Capture Settings**] will be displayed. Menu options will differ depending on which exposure mode is selected.



Playback Menu

This menu is for setting the playback related functions of the still images and movies. The settings for printing, such as DPOF setting, is included in the Playback Settings menu. If **MENU** is pressed during playback mode, [ **Playback Menu**] will be displayed.

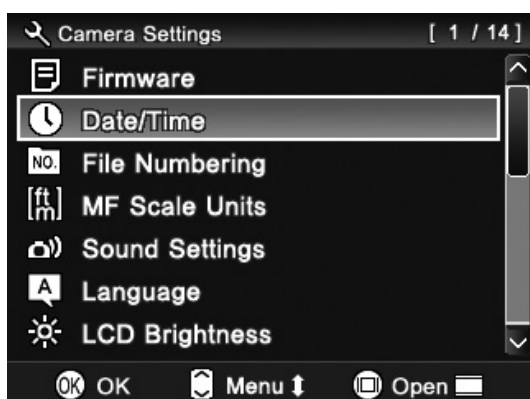

Camera Settings

This menu is used for camera setup such as date and language selection. When the Mode Dial is set to the **SET UP** position, [ **Camera Settings**] will be opened.

WARNING!!

- The Camera Set-up menu will not be displayed in Sound Recording mode.

List Display and Open Display

The Camera Set-up menu of the DP2 camera has two display patterns; List Display and Open Display.

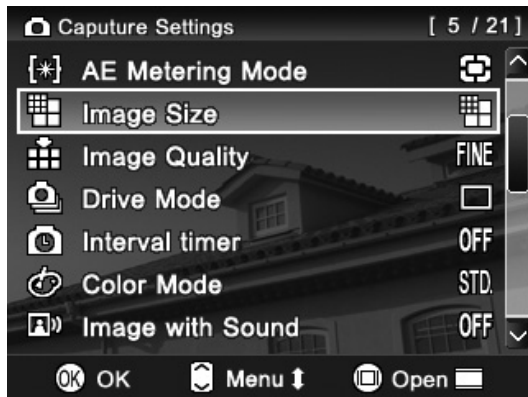

List Display

Menu Items are listed. In [**📷 Capture Settings**], the icon of the current setting option is displayed on the right. It is possible to select Menu Items by pressing the buttons or the buttons.

To change an option, select the desired Menu Item and press the **OK** button to go to the Open Display.

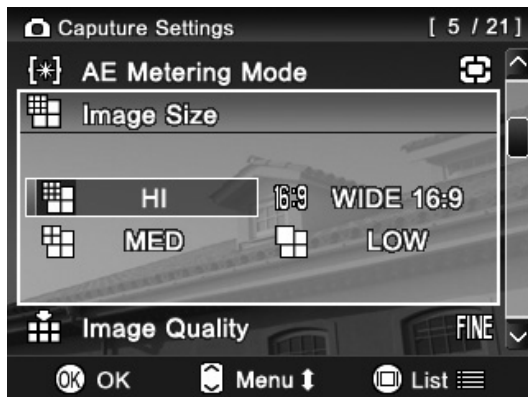

Open Display

Options of selected Menu Items are displayed automatically. The current setting icon is highlighted with a blue color. To change an option, select the desired option by pressing the button. Press the **OK** button to apply the setting.



In the case of some Menu Items, it is necessary to press the **OK** button to display options. In that case, please follow the displayed message.

TIP

- It is possible to move to other Menu Items without exiting from Open Display by pressing the button shown in Open Display.
- When the Camera Set-up menu is displayed, it is possible to change to List Display or Open Display by pressing the button.

- Settings are laid out as follows. Some setting may be different depending on the function. Please refer to the relevant page of each function.

For example, to adjust the [Image Size] setting from [📷 Capture Settings]:

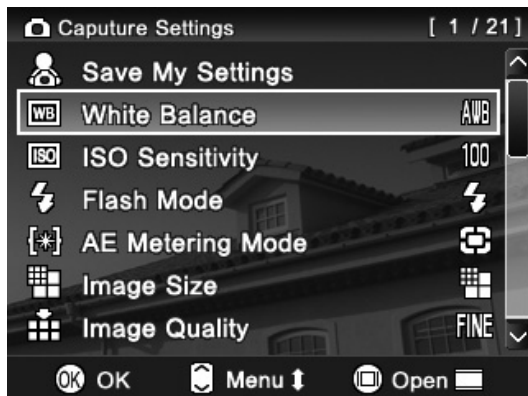

1

Press the **MENU** button whilst the camera is in a still image exposure mode and [📷 Capture Settings] will be displayed.

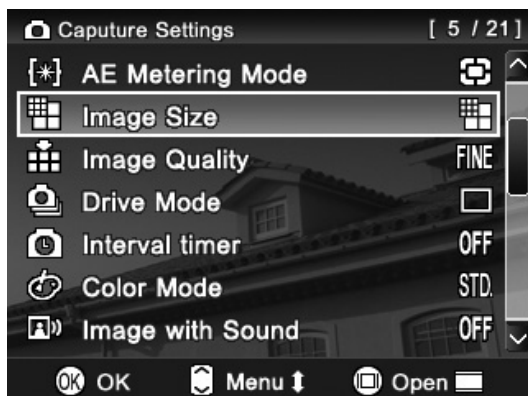

2

Press the **⬇** button and select [Image Size] then press the **OK** button.

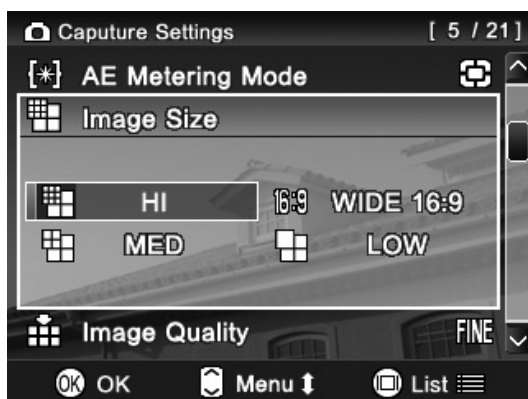

3

In Open Display, select the desired image size by pressing the **⬅➡** button and press the **OK** button to apply the setting. The applied image size will be highlighted in blue.

4

By pressing the **MENU** button or the shutter button “half-way”, the Camera Set-up menu will disappear and the DP2 will be changed to shooting mode.

WARNING!!









- After changing the settings in [🔧 Camera Settings], return the Mode Dial to any position except **SET UP**. If the Mode Dial is set to the **SET UP** position, it is not possible to shoot, review images or play movies.

LIST OF MENU FUNCTIONS













* Designates the default option. Some defaults may vary depending on the country of purchase.

See each corresponding page for more information.





Capture Settings

Menu Item	Mode	Options	Description	Page
 White Balance	P, A S, M 	Auto* Daylight Shade Overcast Incandescent Fluorescent Flash Custom	Selects the White Balance Mode depending on the shooting conditions.	53-55
 ISO Sensitivity	P, A S, M	ISO AUTO* ISO50 ISO100 ISO200 ISO400 ISO800 ISO1600 (RAW) ISO3200 (RAW)	The higher value indicates a higher sensitivity. (The Image may have more “noise” with higher sensitivities.)	56
 Flash Mode	P, A S, M	Normal Flash* Redeye Slow Sync. Redeye + Slow	Selects the Flash Mode depending on the shooting conditions.	47
 Metering Mode	P, A S, M	Evaluative* Center Weighted Average Spot	Selects the Metering Mode depending on the shooting conditions.	60
 Image Size	P, A S, M	HI* WIDE 16:9 MED LOW	Selects recording Image Size.	57
 Image Quality	P, A S, M	FINE* NORMAL (NORM) BASIC RAW	Selects recoding Image Quality. (RAW mode must be selected for users to process images in Sigma PhotoPro.)	58
 Drive Mode	P, A S, M	Single* Continuous Self Timer 2 sec Self Timer 10 sec	Selects the Drive Mode such as Self-Timer.	51,52









📷 Capture Settings

Menu Item	Mode	Options	Description	Page
 Interval timer	P, A S, M	OFF* ON [Interval] [Num. of Times]	Sets the condition or cancels the interval timer.	71,72
 Color Mode	P, A S, M	Standard* Vivid Neutral Portrait Landscape B&W Sepia	Selects the desired Color mode depending on the shooting conditions.	67
 Image With Sound	P, A S, M	Off* 10sec. 30sec.	Sets or cancels the Image With Sound mode.	68
 Color space	P, A S, M	sRGB* Adobe RGB	Sets the color space to [sRGB] or [Adobe RGB].	58
 Picture Settings	P, A S, M	Contrast Saturation Sharpness	Adjusts the Contrast, Saturation and Sharpness.	59
 Quick Preview	P, A S, M	Off 2 sec.* 5 sec. 10 sec.	Sets the duration of the Quick Preview image that is automatically displayed on the color LCD monitor after the image is captured.	75,76
 Grid Segment Display	P, A S, M	Off* — 4 - - - 4 — 9 - - - 9 — 16 - - - 16	Sets or cancels the Grid segment making it convenient for composition.	36
 Auto Rotate	P, A S, M	OFF ON*	Sets or cancels to record the vertical image information.	70
 AEL Button Settings	P, A S, M 	AEL* Center AF Lock Center AF Lock+AEL	Sets the function that the AEL button will perform.	61,62
 Half Pressed AEL	P, A S, M 	OFF ON*	Sets or cancels the exposure lock when the shutter button is pressed “half-way”.	62







Capture Settings

Menu Item	Mode	Options	Description	Page
 Key arrangement	P, A S, M	—	Sets the key arrangement for Exposure level and Exposure compensation in each Exposure mode.	74
 Auto Bracketing Order	P, A S, M	0 → - → +* - → 0 → + + → 0 → -	Sets the order of Auto Bracket.	65,66
 Load My Settings	P, A S, M	A B C	Loads the camera settings that are saved in My settings.	73
 Save My Settings	P, A S, M	A B C	It is possible to save three of your desired camera settings.	73







Playback Menu

Menu Item	Options	Description	Page
 Slideshow	Show all Show locked Show marked Slideshow Settings Duration Repeat	Selects options of the Slideshow Mode.	99,100
 Rotate	Rotate  Rotate 	Rotates the stored image.	95
 Lock	Lock Unlock  Lock  Unlock Lock all Unlock all	Locks or Unlocks files. This can protect files from being deleted accidentally.	89-91
 Mark	Mark Unmark Mark all Unmark all	Marks or Un-marks stored images. This makes it convenient to identify favorite images.	92-94









▶ Playback Menu

Menu Item	Options	Description	Page
 Sound Memo	Off * 10sec 30sec	Sets or cancels the Sound Memo, which can be recorded to a stored image.	97,98
 Exp. Warning	Off * On	Sets whether or not the over - exposure warning is shown on images.	96
 OK Shortcut	None * Lock/Unlock Mark/Unmark Exp. Warning Rotate  Rotate 	Sets the function that the  button will perform during image review.	96
 DPOF	Select / Quantity Select All Images Cancel All Selections	Sets the number of copies to be printed when using a DPOF compatible printer.	109

🔑 Camera Settings

Menu Item	Options	Description	Page
 Date/Time	Date and Time 12H / 24H Y/M/D; M/D/Y; D/M/Y	Sets the date or time recorded with the captured image.	25
 File Numbering	Continuous* Auto reset	Sets the file numbering system used when a new card is inserted in the camera.	113
 MF Scale Units	m(meters)* ft(feet)	Sets the Manual Focus Scale Units when MF is used.	50
 Sound Settings	Shutter Sound Key Sound Sound Volume	Sets the Shutter sound, Key sound and Sound Volume. (It is possible to adjust the Sound Volume by pressing the  button.)	—
 Language/言語	English* 日本語 Deutsch Français Español Italiano 中文(简体字) 한국어 Русский	Sets the language in which menus and messages will be displayed.	24

Camera Settings

Menu Item	Options	Description	Page
 LCD Brightness	—	Sets the color LCD monitor brightness.	—
 LCD Contrast	—	Sets the color LCD monitor contrast.	—
 LCD Sleep	Off 30 sec. 1 min. * 2 min. 5 min.	Sets the delay before the color LCD monitor turns off automatically if no operation has occurred.	114
 Auto Power Off	Off 10 sec. 30 sec. 1 min. 2 min. * 5 min.	Sets the delay before the camera shuts down automatically if no operation has occurred.	114
 Video Mode	NTSC * PAL	Sets the standard to be used for video output when the camera is connected to a television or VCR.	85
 USB Mode	Mass Storage* PictBridge	Selects the “Mass Storage” for connection to a PC or “PictBridge” compatible printer.	106,118
 Format	—	Formats the card. (Formatting will erase all data on the card.)	39
 Reset	Reset Capture Settings Reset Camera Settings (Reset to factory defaults)	Restores all menu options to their default settings. (Default settings are indicated by a *.)	40
 Firmware	—	Confirm current firmware version and update the latest firmware version from card.	—

QUICK SET MENU

It is possible to set the following Menu in [📷 Capture Settings] quickly by pressing the **QS** button.

Qs1 (Quick Set Menu 1)	Qs2 (Quick Set Menu 2)
▲ ISO Setting	▲ Image Size
▼ White Balance	▼ Color Mode
◀ Flash Mode	◀ Image Quality
▶ Metering Mode	▶ Drive Mode

When the camera is in the Still Image Mode, the Quick Set Menu will be displayed by pressing the **QS** button. (By pressing the **QS** button again, it is possible to switch to **Qs1** or **Qs2**.)

Select the desired Menu by pressing the 4-way controller and change the setting.

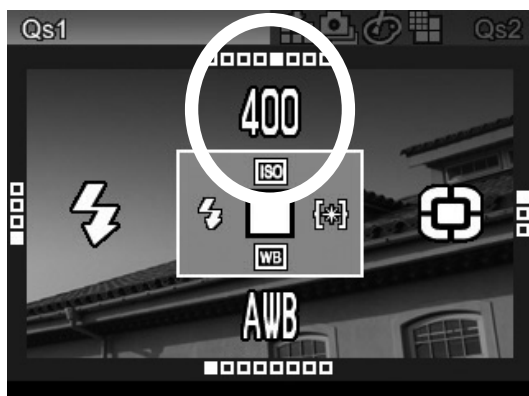

For example, if you wish to change the ISO Setting to 400, press the **QS** button to display Qs1, then set the value to 400 by pressing the ▲ button several times.

By pressing **OK** or the shutter button “half-way”, the settings will be applied and the camera will return to shooting mode.

When you select **Custom** from [White Balance], the current stored setting in [Custom] will be used.

It is not possible to capture a new custom white balance from **Custom** in Quick Set Menu. Please capture a new custom white balance from [📷 Shooting Menu] (P.26) → [White Balance] → [Custom].

WARNING !!

- When Image Quality is selected to **RAW**, Image Size will be set to **(Hi)** automatically. It is not possible to select any other Image Size.

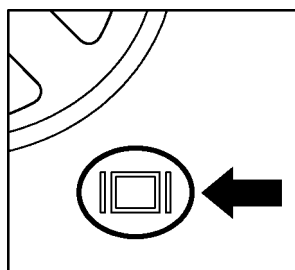
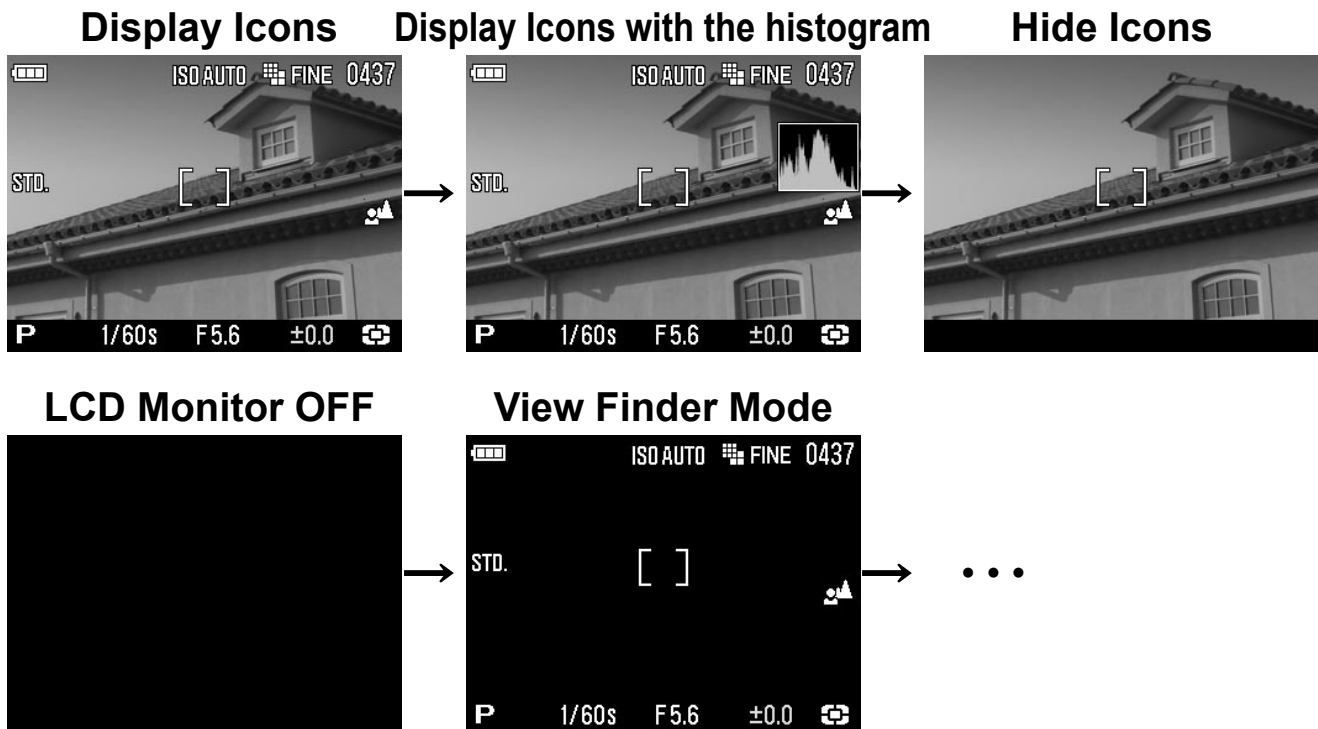

CHANGING THE COLOR LCD MONITOR DISPLAY

It is possible to display/hide icons on the color LCD monitor as follows by pressing the  button.



Each time the  button is pressed, the color LCD monitor display will change as follows.

OPERATION

Still Image Mode (P , A , S)
Display Icons → Display Icons with the histogram → Hide Icons → LCD Monitor OFF → View Finder Mode → ...
Still Image Mode (M)
Display Icons → Hide Icons → LCD Monitor OFF → View Finder Mode → ...
Movie Mode 
Display Icons → Hide Icons → ...
Voice Record Mode 
Display Icons → LCD Monitor OFF → ...

In the View Finder Mode, only Icons will be displayed. This mode is convenient for shooting with the optional View Finder.

REVIEWING

Still Image
Display Icons → Hide Icons → Display Image Info Screen (P.82) → ...
Movie
Display Icons → Hide Icons → ...
Voice Record
Display Icons only

GRID SEGMENT DISPLAY

It is possible to display the grid line when the camera is in Still Image Mode. This function is convenient when composing a picture.



[Shooting Menu] (P.26) → Select the desired display type from [Grid Segment Display].

Off* (Grid Line Off)	
— 4 (4 segments with a solid line)	--- 4 (4 segments with a dotted line)
— 9 (9 segments with a solid line)	--- 9 (9 segments with a dotted line)
— 16 (16 segments with a solid line)	--- 16 (16 segments with a dotted line)

INSERTING AND REMOVING THE CARD

The DP2 camera uses a SD memory card, SDHC memory card and Multimedia card to store data.

TO INSERT THE CARD

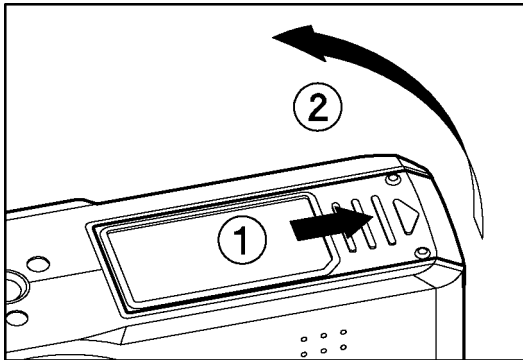

1

Turn off the camera and open the Battery/ Card Cover, as shown in the illustration.

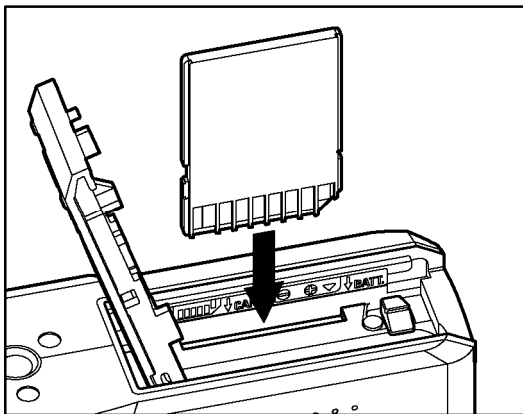

2

Insert the card in accordance with the instruction of Battery/ Card chamber. Insert the card until it clicks.

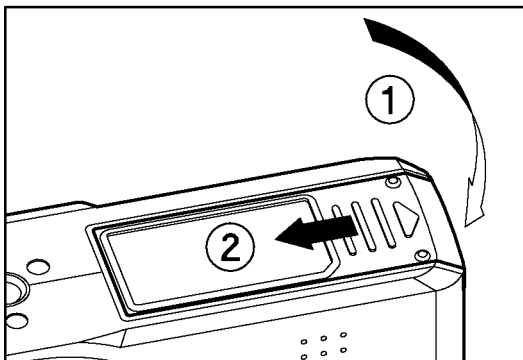

3

Close the Battery / Card Cover.
Slide the Battery / Card Cover in the direction shown by the arrow until it clicks shut.

TIP

- It may be necessary to format the card before use. (See P.39)

TO REMOVE THE CARD

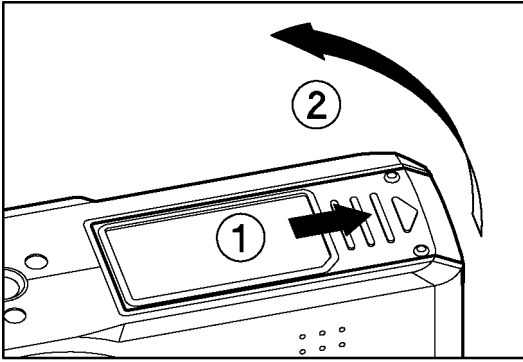

1

Turn off the camera and open the Battery / Card Cover, as shown in the illustration.

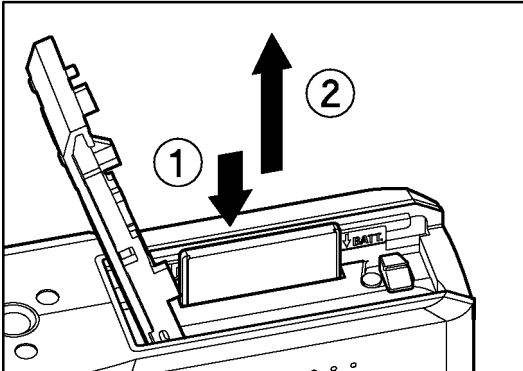

2

Push the card until it clicks and pull out it.

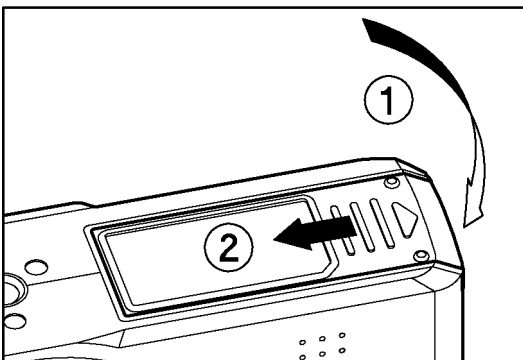

3

Close the Battery / Card Cover. Slide the Battery / Card Cover in the direction shown by the arrow until it clicks and be locked.

CAUTION !!

- Never do any of the following while the Busy Lamp is on. (The Busy Lamp indicates when the camera is writing, reading, or erasing images from the card. Doing any of the following may cause the image data to be lost or corrupt.)
 1. Do not remove the card.
 2. Do not remove the battery.
 3. Do not apply shock or vibrations to the camera.

TIP

- If the camera is turned off while the Busy Lamp is on, the camera will remain on until it has finished accessing the card.

FORMATTING THE CARD

New cards must be formatted before use. In addition, cards with corrupt or incompatible file systems may need to be formatted before use.

[ **Camera Settings**] (P.26) → **Select [Format]** and format the card.



In [**Format**] menu, Select [**Yes**] by pressing the ◀▶ button and press the  button.

To cancel formatting, select [**No**] by using the ◀▶ button and press the  button.

CAUTION !!

- Formatting erases all card contents, including locked DP2 files and all non-DP2 files.

TIP

- Cards formatted in other cameras or devices may not operate correctly in the DP2 camera or may have reduced capacity. To store the maximum number of DP2 files, format the card in the DP2 camera before use.

SHUTTER BUTTON

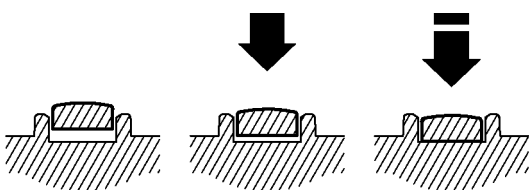

The shutter button of the DP2 cameras has two positions. When you press the shutter button “halfway down”, the camera’s autofocus systems will activate. When pressing the button “all-the-way down”, the shutter will release to take a picture.



TIP

- Before you start to take pictures, we recommend that you operate the camera, to become familiar with the “halfway down” position and other features of the camera.



RESET TO THE DEFAULTS

It is possible to reset the settings to the defaults.

It is possible to reset settings to defaults from [ **Camera Settings**] (P.26) → [**Reset**].





Reset Capture Settings	Reset all settings of [ Capture Settings] to the defaults. (If the My Setting is saved, it will be maintained.)
Reset Camera Settings	Reset the settings of [ Camera Settings] as well as [Slideshow], [Sound Memo], [Exp.Warning] and [OK Shortcut] of [ Playback Menu]
Reset to factory defaults	It is possible to reset to all settings to defaults. (My Setting will be also reset to defaults.)

1

In Open Display of [**Reset**], select the desired option by using the  button and press the  button.

- To select [**Reset to factory defaults**], it is necessary to keep pressing the **AEL** button for a second in the Open Display of [**Reset**].

2



Select [**YES**] by using the  button and press the  button. To cancel the reset settings, select [**NO**] by using the  button and press the  button.

BASIC OPERATION

SELECTING THE EXPOSURE MODE

The features and the operation methods of the four different exposure modes of the camera are explained below.

WARNING !!

- In this section, the instruction is written on the assumption that [  **Key arrangement**] of [ **Shooting Menu**] (P.26) is in the initial setting. If the actual proceeding is different with the instruction manual, see P.74 for instruction of [**EXP. KEY ARRANGEMENT**].

P PROGRAM AE

To make picture taking easier, the camera will automatically select an appropriate combination of shutter speed and aperture value, according to the brightness of the subject.



1

Set the Mode Dial to the **P** position.
(The exposure indicator is illuminated in green.)

2

Press the shutter button “half-way” to verify the focus and take the picture.

WARNING !!

- When  is shown on the color LCD monitor, the camera is set slower than 1/25). If this mark is displayed, please use the flash (P.46, 69) or a tripod.
- If the subject is too bright or dark, both shutter speed and aperture value indicators will blink and will show the limit values. If you take a picture with these settings, the picture will be overexposed or underexposed.

PROGRAM SHIFT

You can change the combination of shutter speed and aperture value, which were automatically selected by the camera. Use the  button to set the desired combination of shutter speed and aperture value.

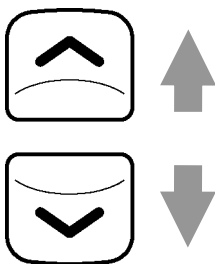

- It will be canceled automatically, after taking the picture.

A APERTURE PRIORITY AE

After you set the aperture, the camera will determine the appropriate shutter speed. If you select smaller apertures, depth of field will be greater. Larger apertures tend to blur the background, as depth of field will be shallower.

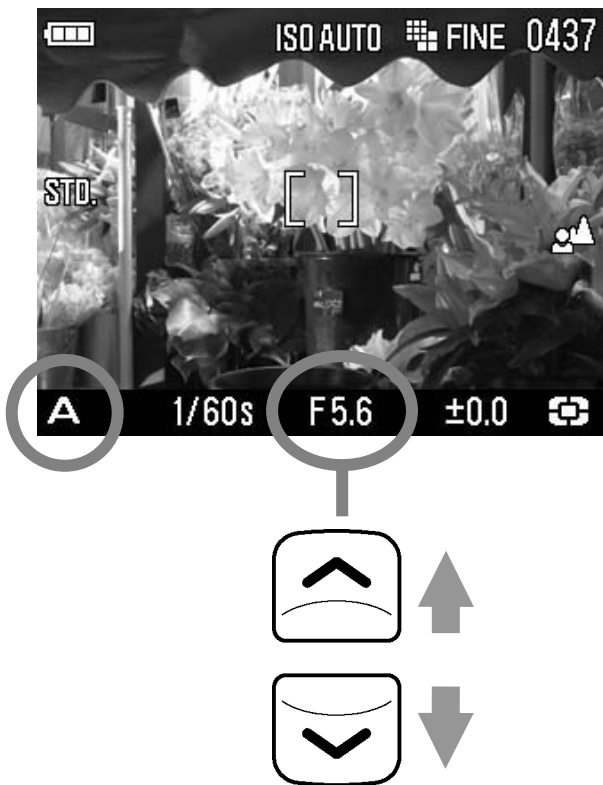

1

Set the Mode Dial to the **A** position.
(The aperture value indicator is illuminated in green.)

2

Select the desired aperture value by using  button.

(The aperture value can be set in 1/3 stop increments from F2.8 to F14.)

3

Press the shutter button “half-way” to verify the focus and take the picture.

WARNING !!

- When  is shown on the color LCD monitor, camera shake may occur (the shutter speed is set slower than 1/25). If this mark is displayed, please use the flash (P.46, 69) or a tripod.
- If the appropriate shutter speed is outside the range of suitable combinations due to the subject being too bright or too dark, the shutter speed indicator will blink. If the subject is too bright, set the aperture value to a smaller one (larger F-number). If the subject is too dark, set the aperture value to a larger one (smaller F-number) until the indicator stops blinking.

S SHUTTER SPEED PRIORITY AE

When you set the desired shutter speed, the camera will select the appropriate aperture value for correct exposure. You can achieve stop action effects by selecting a fast shutter speed, or give the feeling of motion to a moving subject by selecting a slow shutter speed.

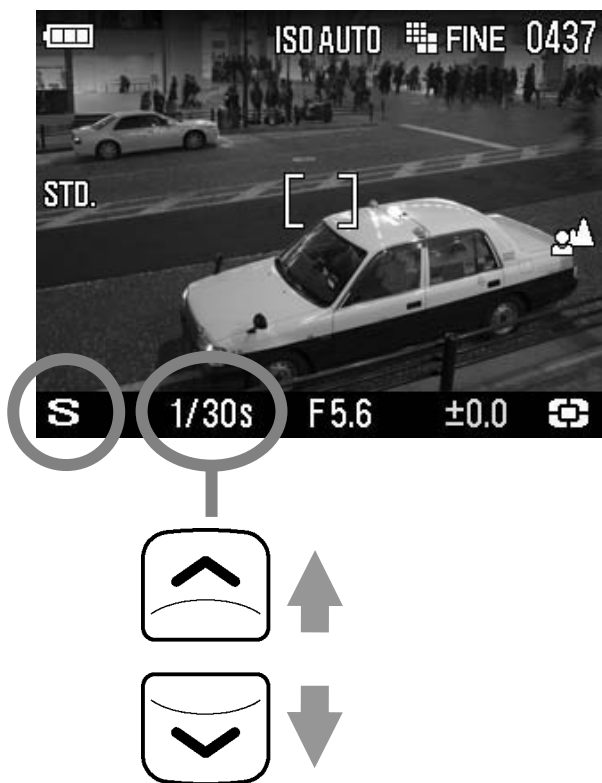

1

Set the Mode Dial to the **S** position.

(The shutter speed value is illuminated in green.)

2

Select the desired shutter speed value by using  button.

(The shutter speed value can be set in 1/3 stop increments from 15 seconds to 1/2000 seconds.)

3

Press the shutter button “half-way” to verify the focus and take the picture.

WARNING !!

- If the appropriate aperture value is beyond the range of the lens in use, due to the subject being too bright or too dark, the aperture value indicator will blink. If the subject is too bright, set the shutter speed to a faster one, or if the subject is too dark, set the shutter speed to a slower one, until the indicator stops blinking.

M MANUAL EXPOSURE

Set both the shutter speed and aperture value according to the indication of the exposure meter. You can change the exposure, as you desire.

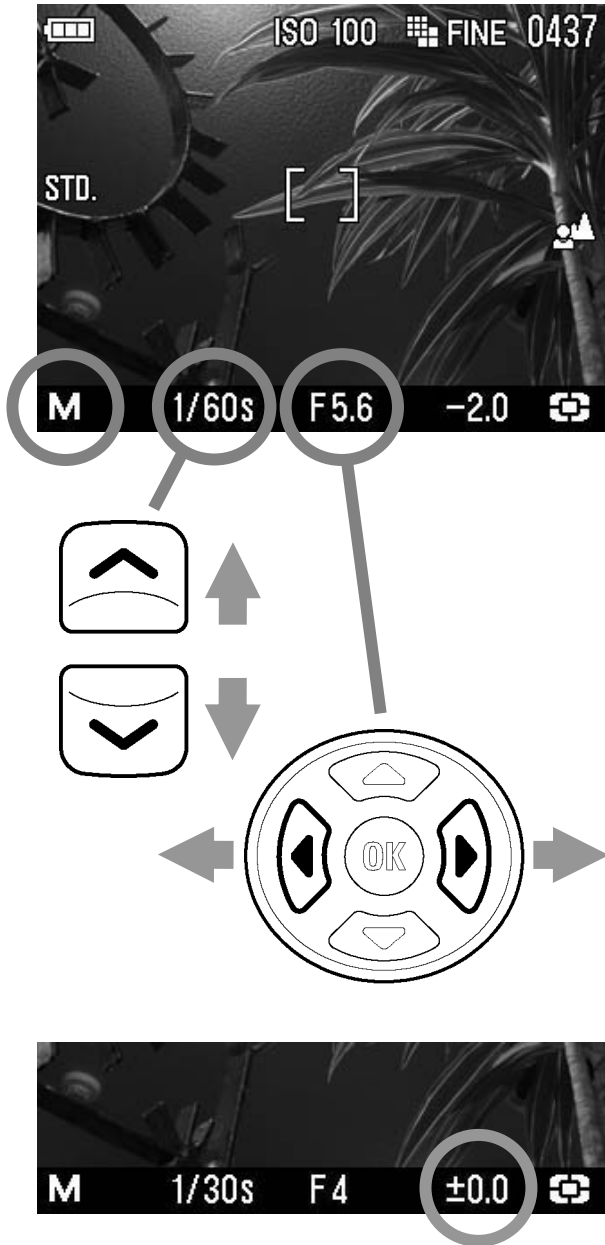

1

Set the Mode Dial to the **M** position.
(The shutter speed value is illuminated in green. The aperture value is illuminated in orange.)

2

Select the desired shutter speed value by using  button.

3

Set the exposure value to **±0.0** by using  button.

- The exposure meter can display an exposure error of up to ± 3 stops from the correct exposure in $1/3$ steps. If the exposure error is more than three stops, the exposure meter will blink.

4

Press the shutter button “half-way” to verify the focus and take the picture.

USING THE BUILT-IN FLASH

The cameras have built-in flash for taking pictures at night or in low light, which is very convenient.

USING THE BUILT-IN FLASH

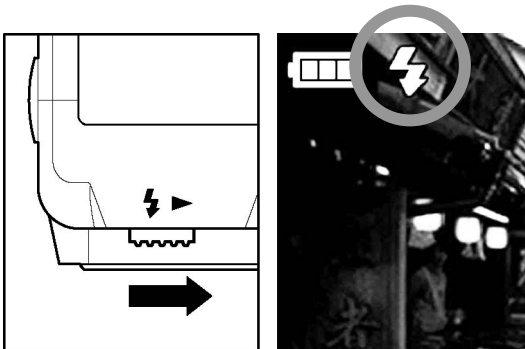

1

Eject the flash by sliding the Flash Pop-Up Lever.

2

Make sure that the Flash Mode icon is displayed on the color LCD monitor.

- While the built-in flash is charging, ⚡ and Auto Focus Lamp blink and the shutter cannot be released.
- When you have finished using the built-in flash, please return the built-in flash to its original position.

■ Flash photography can be used in the following range. (**P** Mode)

ISO	Flash Exposure Range
ISO AUTO	0.28m ~ 4.3m
ISO50	0.28m ~ 1.5m
ISO100	0.28m ~ 2.1m
ISO200	0.28m ~ 3m
ISO400	0.28m ~ 4.3m
ISO800	0.28m ~ 6.1m
ISO1600(RAW)	0.28m ~ 8.6m
ISO3200(RAW)	0.28m ~ 12.1m

SETTING THE FLASH MODE

It is possible to select other flash modes such as Exposure Compensation mode or Red-Eye Reduction mode.

The Flash Mode can be set in the Quick Set Menu (**P.34**) or [**Camera Capture Settings**] (**P.26**) → [**Flash Mode**].

	Normal Flash *
	Redeye
	Slow Sync.
	Redeye + Slow

NORMAL FLASH

When you pop-up the built-in flash, you can use your camera in this mode.

- Please use this mode for ordinary photography.

RED-EYE REDUCTION FLASH (Redeye)

When taking a picture with flash, sometimes the person's eyes reflect the flash light and the "redeye" phenomenon will appear in the picture. In order to avoid this effect, the flash will blink several times, for about one second before the picture is taken, in order to reduce the effect of this phenomenon.

- Depending on the lighting and subject conditions, the Redeye Reduction flash may not completely eliminate the redeye in all cases.

SLOW SYNCHRO MODE

When using the flash with **P/A** mode, the shutter speed value is limited to faster than 1/40. The slow synchro mode changes the shutter speed up to 15 second depending on light condition. This mode is suitable for a portrait in a nightscape.

FOCUSING

Adjustment of autofocus and manual focus operation are explained below.

HOW TO USE AUTOFOCUS



Position the photographic subject within the centre of the composition and press the shutter button “half-way”.

- If autofocus is selected, the focusing point will be illuminated in green. (At the same time, the auto focus lamp will be illuminated in green.)
- If autofocus cannot set correctly, the focusing point will blink. (At the same time, the auto focus lamp will blink in red)

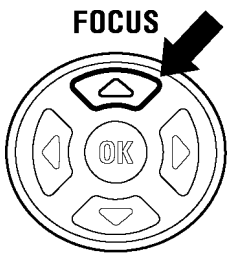

When setting AF mode to normal autofocus (without an icon), the focusing distance is from 28cm to infinity. It is possible to change AF mode to LIMIT mode (▲ is displayed) by pressing the **FOCUS** button. In LIMIT mode, the focusing distance will be from 1m to infinity and the AF speed will be faster.

Although your camera is equipped with highly precise AF system, in some cases autofocus cannot set correctly.

- Low-contrast subjects, such as blue sky or a blank wall, etc. or when the color of the subject is same as background
- The subject is located in a very low light environment
- Overlapping near and far objects, such as an animal behind a fence
- A subject, which moves at high speed

In such cases, please use one of the following focusing methods.

1. Use the Focus Lock function to focus on another subject, which has a similar focusing distance as your subject.
2. Set the lens to MF mode and focus manually.

FOCUSING POINT SELECTION





The DP2 is equipped with 9 focusing points and it is possible to select the desired focusing point.

1

Press the  button.

2

Press the  button to select the desired focusing point, and press the  button to apply it.

FOCUS LOCK

This photographic method is useful if the subject is not positioned within the selected focusing point.

1

Position the photographic subject into the selected focusing point, and focus by pressing the shutter button “half-way”.

2

When the subject is in focus, the selected focusing point will be illuminated in green. Press the shutter button to take the picture.



MANUAL FOCUS

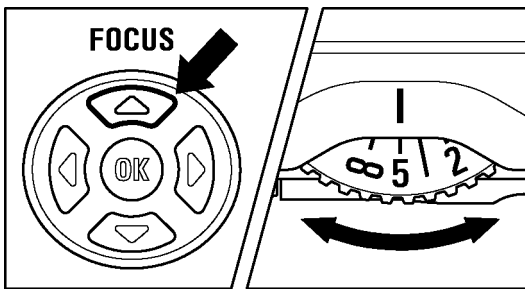

In situations where autofocus or focus lock is not effective, you can focus manually.

1

Set the focus mode to MF mode by pressing **FOCUS** button several times. (**MF** icon and “the scale bar” will be displayed on the color LCD monitor).

2

Turn the MF Dial on the camera body until you get a clear sharp image.

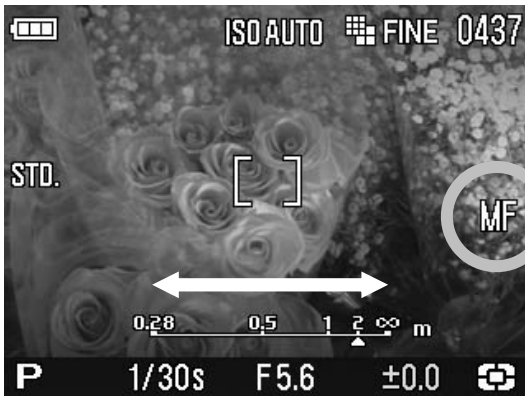

FOCUSING WITH MAGNIFICATION DISPLAY

Pressing the **OK** button and then pressing the **▲** button while in MF mode will magnify the display, making it easier to focus precisely. (By pressing the **▲** button, it is possible to switch to magnification display or normal display.)

- Whilst the display is enlarged, the **Q** is displayed on the color LCD monitor. Press the shutter button “half-way” to return to the original display.
- To quit magnification display, press the **▲** button to return to normal display, then press the **OK** button.
- The enlarged display will be magnified from the selected focusing point of the LCD monitor by pressing **|□|** button. It is possible to set the enlarged area to be the same as the focusing point selection. See **P.49** for information regarding focusing point.

WARNING!!

- The graduation on the MF Dial and the scale bar may differ from the actual distance. Please use it as a guide only.

TIP





- It is possible to change the indicator of the scale bar. Select **m (meter)** or **ft (feet)** from [**Camera Settings**](P.26)→[**MF Scale Units**].

OPERATION OF THE DRIVE MODE

Operation of the self-timer, and other functions of the camera are explained by the following:



Operation of The Drive Mode can be set in Quick Set Menu or [ Capture Settings] (P.26) → [Drive Mode].

	Single Capture*
	Continuous
	Self Timer 2 sec.
	Self Timer 10 sec.

SINGLE FRAME SHOOTING

[Single Capture]

When you press the shutter button in the single frame-shooting mode, only one frame will be exposed. Then the camera will be ready for the next shot by advancing one frame. Single frame shooting mode is recommended for ordinary photography.

CONTINUOUS SHOOTING

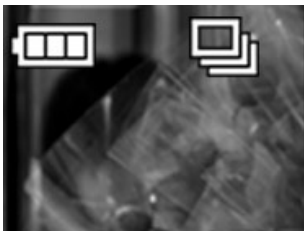

[Continuous]

In this mode, when you keep the shutter button fully depressed, the camera will take pictures continuously.

- When the camera is in continuous mode, the maximum number of frames is four in JPEG and three in RAW.

CAUTION !!

- Images taken in rapid succession, such as during Continuous shooting, are initially stored in the camera's internal memory buffer. Once the memory buffer is full, the shutter will be disabled until some images have been transferred to the card.

SELF TIMER

When you want to include yourself in the picture or avoid camera shake, please use the self-timer.



[Self Timer 2 sec]

The shutter will be released 2 seconds after the shutter button is fully depressed.



[Self Timer 10 sec]

The shutter will be released 10 seconds after the shutter button is fully depressed.

After composing the picture, press the shutter button “half-way” and adjust the focusing. Then, press the shutter button the rest of the way and the self-timer will activate. During the self-timer operation you will hear an electronic beeping sound. The beeping sound will be much faster during the last two seconds, before the shutter is released.

- When [**Camera Settings**] (P.26) → [**Sound Settings**] → [**Key Sound**] menu is set to [**Off**], the electronic sound will not beep even if the self-timer is operated.

- If you want to cancel the self-timer operation, please turn off the camera.

ADVANCED OPERATION







This section explains the application of the more advanced functions of your camera, when composing the expressions of your picture.

SETTING THE WHITE BALANCE (WB)



The color of light reflected by an object can vary depending on the color of the light source illuminating it. For example, a neutral colored object will reflect reddish light under incandescent lighting, and greenish light under fluorescent lighting. The human brain is able to compensate for differences in the color of a light source, allowing us to see white objects as white, independent of the lighting condition. Film cameras rely on special color-correcting filters and film types to adjust for these differences in lighting. Digital cameras, however, are able to use software to mimic the adjustments made by the brain, so that colors that appear white to the human eye also appear white in your photographs.



WHITE BALANCE OPTIONS

	OPTION	COLOR TEMP.	DESCRIPTION
(AWB)	Auto *	—	Select this setting to allow the camera to automatically determine the appropriate white balance adjustments.
	Daylight	Approx. 5400 K	Select this setting when taking pictures in full sunlight.
	Shade	Approx. 8000 K	Select this setting when taking pictures in the shade under sunny skies.
	Overcast	Approx. 6500 K	Select this setting when taking pictures under cloudy, overcast skies.
	Incandescent	Approx. 3000 K	Select this setting when taking pictures indoors under incandescent (tungsten) lighting.
	Fluorescent	Approx. 4100 K	Select this setting when taking pictures indoors under fluorescent lighting.
	Flash	Approx. 7000 K	Select this setting when taking pictures with the Sigma EF-140 DG SA-STTL flash.
	Custom	—	Select this setting when using a custom white balance. Use the "Set Custom WB" menu option to create a custom white balance setting. The "Custom" option will not be available if no custom white balance has been set.

The White Balance can be set in Quick Set Menu (P.34) or [ Shooting Menu] (P.26) → [White Balance].



When you select  (Custom) in Quick Set Menu, the current stored setting in [ Shooting Menu] → [White Balance] → [ Custom] will be used.

To capture a new custom white balance, please set it from [ Shooting Menu] (P.26) → [White Balance] → [Custom] (See next page).

SETTING A CUSTOM WHITE BALANCE

For more precise control of the white balance setting or when photographing under unusual lighting conditions, the "**Set Custom WB**" option can be used to capture a sample of neutral object in a scene to be used for color correction.

1

To capture a custom white balance image, please select [ **Capture Settings**] (P.26) → [**White Balance**] → [**Custom**], then press the  button.

2

Under the lighting conditions that will be used for the final photograph, frame a white color object, such as a sheet of white paper or a white wall, so that it fills the frame in the center of the color LCD monitor, and then press the shutter button.

If a valid white balance settings was captured, a message "**White balance image captured successfully**" will appear on the color LCD monitor that the white balance image was captured successfully.

If the capture was not successful, "**Failed ! Please retry the custom WB capture.**" will be displayed on the color LCD monitor.

Press the shutter button to capture a white balance image once again.

To dismiss the capture, press the **MENU** button.

TIP

- When the  button is pressed in white balance capture display, current white balance setting will be set.

SETTING THE SENSITIVITY (ISO EQUIVALENCY)



The photosensitivity of digital cameras is described in terms of “ISO equivalent” like silver-halide film cameras. (ISO sensitivity **P.112**)

The ISO Sensitivity can be set in Quick Set Menu (**P.34**) or [**Camera Capture Settings**] (**P.26**) → [**ISO Sensitivity**].

ISO Auto*	ISO 50
ISO 100	ISO 200
ISO 400	ISO 800
ISO 1600 (RAW)	ISO 3200 (RAW)



- It is possible to select an ISO value from 50 to 800 in JPEG mode or from 50 to 3200 in RAW mode.

CAUTION!!

- If [**ISO Auto**] is selected, the ISO value will automatically change to ISO 100 or 200 depending on the light condition. When using the flash, the ISO value is changed to ISO 100, 200 or 400 automatically.

IMAGE FILE SETTING

The file size changes depending on resolution mode and recording quality selected.

		Image Size (Resolution mode)			
		 HI 2640×1760	WIDE 16:9 2640×1485	 MED 1872×1248	 LOW 1312×880
Image Quality	RAW (RAW)	15.4MB			
	FINE (JPEG)	3.3MB	2.7MB	1.6MB	0.8MB
	NORMAL (JPEG)	1.9MB	1.6MB	0.9MB	0.5MB
	BASIC (JPEG)	1.4MB	1.2MB	0.7MB	0.3MB

* The file sizes change depending on subjects.

IMAGE QUALITY



It is possible to record images in the widely used JPEG or RAW formats.

The RAW images are recorded without digital processing in the camera body and require post-processing with the supplied software, which can convert RAW images to JPEG or TIFF format.



IMAGE SIZE SETTING

Image Size Setting can be set in Quick Set Menu (P.34) or [ Capture Settings] (P.26) → [Image Size].

 HI *	WIDE 16:9
 MED	 LOW

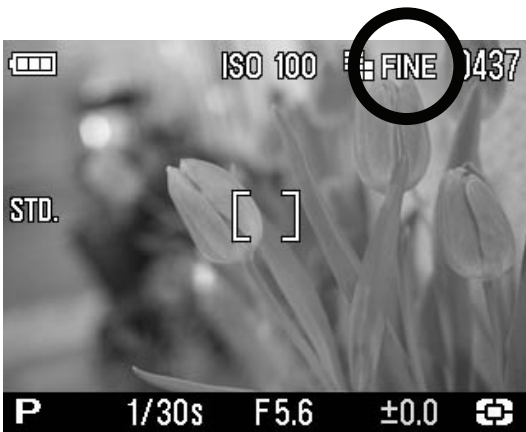

IMAGE QUALITY SETTING

Image Quality Setting can be set in Quick Set Menu(P.34), or [Capture Settings] (P.26) → [Image Quality].

FINE * (JPEG)	NORMAL (NORM) (JPEG)
BASIC (JPEG)	RAW (RAW)

WARNING !!

- When Image Quality is set to RAW, the Image Size is automatically set to **Hi**. (The icon of Image Size is not displayed on the LCD monitor.)
- When the Image Quality is set to RAW, the Image Size cannot be changed until the Image Quality is changed.

COLOR SPACE

It is possible to select sRGB, which is a common color space or Adobe RGB, which is mainly used for commercial printing, and other industrial purposes.

Color Space can be set in [Capture Settings] (P.26) → [Color Space].

sRGB *	Adobe RGB
---------------	------------------

CAUTION !!

- Please set the color space to sRGB for regular usage. If you select Adobe RGB, please be sure to use the supplied Sigma Photo Pro software or another image processing software supporting DCF 2.0.

PICTURE SETTINGS

It is possible to adjust the recording image parameter (contrast, sharpness and saturation).

● Contrast

Contrast can be increased by moving the cursor to + side, or decreased, preserving image detail, by moving the cursor to - side.

▣ Sharpness



It is possible to make the pictures appear sharper, by moving the cursor to + side, or softer by moving the cursor to - side,.

⚡ Saturation

It is possible to increase saturation thus making pictures appear vivid, if the cursor is moved to + side. Moving the cursor to - side, decreases saturation and makes images less vivid.

Picture Settings can be set in [ **Capture Settings**] (P.26) → [**Picture Settings**].



Use the  arrows on the 4-way controller to select [**Contrast**], [**Saturation**], [**Sharpness**] from [**Picture Settings**], then press the  arrows on the 4-way controller to adjust the compensation.

Press the  button to apply the setting or the **MENU** button to close the sub-menu without making any changes.



If you adjust image parameters, their icon is displayed on the left of the color LCD monitor.

TIP

- JPEG is compressed after parameter adjustment. In the case of RAW format, parameter information is recorded without adjustment. It is possible to re-adjust RAW images using the supplied Sigma Photo Pro software.

SELECTING THE METERING MODE



The camera has three advanced metering modes.

The Metering Mode can be set in Quick Set Menu (P.34) or [📷 Capture Settings] (P.26) → [Metering Mode]

	Evaluative *
	Center Weighted Average
	Spot

EVALUATIVE METERING

The camera measures the brightness of the scene by independently measuring each segment of the focusing screen and analyzing the correct exposure for the main subject under any lighting situation. Even under strong back lighting or complex lighting situations, the camera will give you the correct exposure.

CENTER WEIGHTED AVERAGE METERING

The camera will measure the average brightness of the entire scene with additional emphasis on the center area. It will determine the most suitable exposure with respect to lighting conditions.

SPOT METERING

The camera will measure the brightness only inside of the center focusing point on the color LCD monitor. This mode is suitable when you wish to set exposure for a portion of the scene and ignore the influence of rest of the scene.

AE LOCK

The camera will fix and memorize the exposure value whilst the “AE” Lock button is depressed. When you wish to lock the exposure of a subject off-center, AE lock is very useful. Use of this function with Spot Metering Mode is recommended.

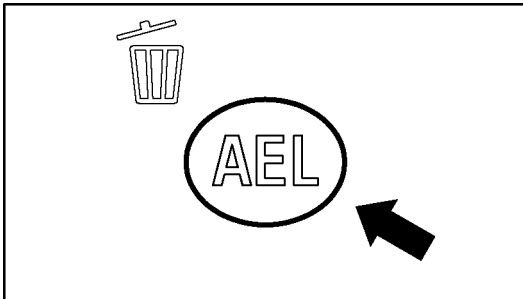

1

Center the subject, for which you wish to lock the exposure, inside the color LCD monitor and press the **AEL** button.

(The exposure value is memorized and AEL is displayed in the upper part of the color LCD monitor.)

2

Compose the picture and press the shutter button.



- It is possible to continue taking pictures with the memorized exposure value until this setting is disabled by pressing the **AEL** button again.

SETTING THE AEL BUTTON

It is possible to use the **AEL** button to select settings other than AE Lock [**AEL**].

The AE Lock can be set in [**Camera Capture Settings**] (P.26) → [**AEL Button Settings**].

AEL*
Center AF Lock
Center AF Lock+AEL



[Center AF Lock]

Ensure the subject is within the center focusing point and press the **AEL** button to activate and lock the autofocus. Please note, only the center focusing point will be used when the **AEL** button is pressed. The exposure will only be locked when the shutter button is depressed “half-way”.



[Center AF Lock + AEL]

Ensure the subject is within the center focusing point and press the **AEL** button. This will activate and lock the autofocus and exposure. Please note, only the center focusing point will be used when the **AEL** button is pressed.

HALF PRESSED AEL

It is possible to set the exposure lock when the shutter button is pressed “half-way” or cancel the exposure lock.

The Half Pressed AEL mode can be set in [**Capture Settings**] (P.26) → [**Half Pressed AEL**].

OFF	The exposure will not be locked while pressing the shutter button “half-way”. The exposure will be determined when depressing the shutter button.
ON *	The exposure will be locked when the shutter button is pressed “half-way”. While pressing the shutter button is “half-way”, the exposure will not change.

EXPOSURE COMPENSATION

If you want to intentionally overexpose or underexpose the picture, use this function.



Select the desired compensation value by using the ◀▶ buttons.

- Exposure compensation can be set in 1/3 stop increments from +3.0 to -3.0 stops.

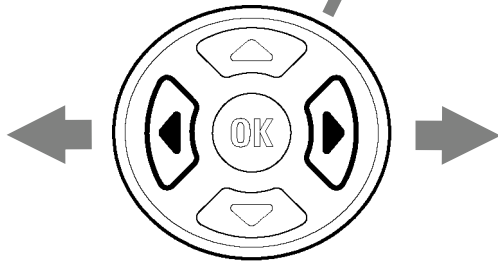

CAUTION !!

- The exposure compensation will not disable automatically. After taking the picture, set the compensation value to ± 0.0 by pressing ◀▶ button.
- Exposure compensation function cannot be used with Manual Operation mode.

FLASH EXPOSURE COMPENSATION

It is possible to compensate the flash output level without changing the background's exposure.



1

Press the **OK** button after ejecting the flash by using the Flash Pop-up lever. (The Allocate function guide will be displayed on the bottom of the LCD monitor. The  icon and the orange compensation value will be displayed in the upper-left corner of the LCD.)

- It is not possible to set the Flash Exposure Compensation if the built-in flash is in the inserted position.

2

Select the desired compensation value by using **◀▶** buttons.

- Exposure compensation can be set in 1/3 stop increments from +3.0 to -3.0 stops.

3

Press the **OK** button again to apply the settings. (The color of the compensation value will turn from orange to white and the Allocate function guide will disappear)

CAUTION!!

- The exposure compensation will not disable automatically. After taking the picture, set the compensation value to ± 0.0 by above procedure.

AUTO BRACKETING

This function of the camera lets you take a sequence of pictures of the same subject at three different exposure levels; Appropriate Exposure, Under Exposure and Over Exposure. If it is difficult to determine the proper exposure, please use this function.



1

Press the **OK** button. (The bracketing amount will change into the Allocate function guide. The  icon and the green bracketing amount will be displayed on the left corner on the LCD monitor.

- It is not possible to set the Auto Bracketing mode if you pop-up the built-in flash.

2

Use the  buttons to set the bracketing amount.

- It can be set in 1/3 stop increments up to ± 3

3

Press the **OK** button to apply the exposure. (The bracketing amount will change from green into white. The Allocate function guide will disappear.)

- The camera will take three pictures in the following sequence; Appropriate exposure, under exposure and over exposure.
- The exposure bracketing can be used with 4 different modes.
 - P** Mode ; Both shutter speed and aperture value will be changed.
 - A** Mode ; Only shutter speed will be changed.
 - S** Mode ; Only aperture value will be changed.
 - M** Mode ; Only shutter speed will be changed.

TIP

- Three frames will be taken continuously by pressing the shutter button. When the Drive Mode is set to the Self Timer, only 1 frame will be taken each time the shutter button is pressed.

TIP

- If the [Quick Preview] in the [📷 Capture Settings] menu is set to other than [Off], three images can be viewed at a time. It is easy to check the exposure difference between the images.

WARNING !!

- Once you set the auto bracketing mode, the camera will continuously hold that auto bracketing mode until you set the bracketing amount to “±0.0”.
- Auto Bracketing function cannot be used with the flashgun. When the built-in flashgun is popped up, the Auto Bracketing function will be turned off.

- Auto bracketing icon will change as follows depending on the frame number.

First Frame	Second Frame	Third Frame
		

- It is possible to change the Auto Bracketing Order.

The Auto Bracketing Order can be set in [📷 Capture Settings] (P.26) → [Auto Bracketing Order]

0 → - → +*	appropriate exposure → under exposure → over exposure
- → 0 → +	under exposure → appropriate exposure → over exposure
+ → 0 → -	over exposure → appropriate exposure → under exposure

Auto Bracketing mode can be used in combination with Exposure Compensation.

You can take pictures with Auto Bracketing mode based on a compensated exposure, which you set.

To do so, please set both the Auto Bracketing mode and Exposure Compensation mode as desired.

The combined value (Exposure Compensation and Auto Bracketing) will be indicated on the viewfinder display.



Example : Exposure Compensation +1.7 with Auto Bracketing amount 1.0

First Frame	+1.7 (Exposure compensation +1.7 & no shift value)
Second Frame	+0.7 (Exposure compensation +1.7 & shift value -1.0)
Third Frame	+2.7 (Exposure compensation +1.7 & shift value +1.0)

COLOR MODE

It is possible to select the desired Color mode depending on the shooting conditions. In addition to the above settings, it is also possible to select Sepia and Monochrome (B&W) photography modes.

The Color Mode can be set in the Quick Set Menu (P.34) or [📷Capture Settings] (P.26) → [Color Mode]

STD. Standard*	Standard color mode for various situations.
VIVID Vivid	Saturation and contrast are enhanced for making pictures appear vivid.
NTR. Neutral	Subdued saturation and contrast makes images natural.
 Portrait	This color mode makes skin tone soft. It is ideal for portraits.
 Landscape	This mode makes blue and green more vivid and emphasizes pictures.
B/W B&W	It is possible to take Monochrome pictures.
SEPIA Sepia	It is possible to take Sepia and monotonous pictures.



- The selected color setting icon is displayed on the color LCD monitor.

TIP

- It is possible to make pictures according to your intension by the combination of Color Mode and Picture Settings. For example, when Color Mode is set to Vivid and the cursor of Saturation in Picture Settings is set to + side, pictures will be made more vivid.

IMAGE WITH SOUND

It is possible to record sound after taking a picture. This function is convenient for recording shooting information at the time of taking the photograph.

- It is possible to select a record time of 10 seconds or 30 seconds.

The Image with Sound can be set from [**📷 Capture Settings**] (P.26) → [**Image with Sound**].

Off * (No sound recording)
10sec
30sec



When the Image with Sound is set,  and the counter is displayed at the upper right of the color LCD monitor.

Press the shutter button and sound will start recording after the image has processed (it takes few seconds to process). During recording,  and the busy lamp blinks, and the counter at the upper right on the color LCD monitor begins to countdown.

The recording stops automatically when the selected record time is up. To stop the recording before the selected record time passes, simply push the shutter button again.

Please see **P.81** for information on viewing images with sound.

WARNING !!

- Once Image with sound is set, the camera will continue to hold this setting until [**Off**] is selected in [**Image with Sound**].

TIP

- The sound recording will be stored as a WAV file. It will be stored in the same folder and have the same file name as the image file. For example, the image file name will be SDIM0010.JPG and sound file name will be SDIM0010.WAV.

USING THE EXTERNAL FLASH

The DP2 camera is equipped with a hot shoe, allowing the use of you a compact, dedicated, external flashgun. Power from the external flashgun is greater than the built-in flash. It is also possible to use the external flashgun with the cameras' lens hood attached.

ELECTRONIC FLASH EF-140 DG SA-STTL (SOLD SEPARATELY)

- Maximum Guide Number of 14 (ISO100) giving 2.3x greater exposure compared to the built-in flash.
- The TTL exposure is controlled by the automatic S-TTL system.
- This flash unit uses two "AAA" type Ni-MH batteries allowing it to have a compact design.
- It is also possible to use the EF-140 DG SA-STTL in manual mode.
- It can be used with the SD14 digital SLR camera and its exposure will be controlled with the S-TTL system.

AUTO ROTATE

It is possible to record the vertical image information to images.

The Auto Rotate can be set by [ **Capture Settings**] (P.26) → [**Auto Rotate**].

Off	The vertical image information will not be recorded.
On*	The vertical image information will be recorded.

The default setting is [**On**].

- When vertically orientated images are reviewed, they will automatically rotate and be displayed vertically.
- When vertically orientated images are reviewed in Sigma Photo Pro, they will automatically rotate and be displayed vertically.
- When vertically orientated images are rotated by pressing [ **Playback Menu**] → [**Rotate**], this rotated orientation will be stored.

WARNING !!

- If the images are taken while the camera is pointed up or down, the vertical position information may not be recorded properly.

INTERVAL TIMER

It is possible to take pictures automatically at selected intervals.



WARNING !!

- The interval timer shooting will be terminated automatically if the battery is empty. We recommend using the AC adapter “SAC-3” (sold separately).

The Interval Timer can be set from [ **Capture Settings**] (P.26) → [**Interval timer**].

In Open Display, select [**On**] to jump to the Interval Timer setting menu.



1

Select [**Interval**] by pressing the  button and set the desired intervals by using the  button.

- It is possible to select from following.

30 sec., 1 min., 5 min., 10 min., 15 min., 30 min., 45 min., 1 h, 3 h, 6 h, 12 h, 24 h.

2

Select [**Num. of Times**] by pressing the  button and set the desired number of exposures by using the  button.

- It is possible to select from following number of exposures.

2, 3, 5, 7, 10, 20, 30, 40, 50, 75, 99, ∞ (unlimited)

3

Press the  button to apply the setting and start the interval timer shooting by pressing the shutter button.

- During the interval timer shooting, the next exposure interval begins and the numbers of remaining exposures will be displayed.
- During the interval timer shooting, the color LCD monitor will be turned off by the LCD Sleep setting. A few seconds before the next exposure, the color LCD monitor will be turned on. This will be repeated for the duration of the process.

- When the focus mode is set to AF, the AF will be locked at the first frame. From the second frame, pictures will be taken with the same focus position as the first frame.
- When the focus mode is set to MF, it is possible to change the focus during the interval timer shooting by turning the MF Dial.
(It is not possible to magnify the display from the second frame.)
(If you wish to keep the same focus position, ensure the MF dial is not turned during the interval timer shooting.)
- Exposure value is measured at each interval shooting. If you wish to take pictures with the same exposure value, set the Exposure Mode to Manual Exposure or fix the exposure value by pressing the AEL Button before shooting.
- To terminate the interval timer shooting, press the Shutter button.
- When the Drive Mode is set to Self Timer, Self Timer will only operate for the first exposure.
- When the Drive Mode is set to Continuous, four frames will be taken in JPEG or three frames will be taken in RAW continuously at each interval shooting.
- When Auto Bracketing is set, three frames will be taken continuously at each interval timer.

WARNING !!

- Once you set the Interval Timer, the camera will continuously hold that Interval Timer. To dismiss the Interval Timer, select **[Off]** in Open Display.
- Depending on the settings, it takes time process the image. It may make the actual interval time longer than the selected time.

MY SETTINGS

It is possible to customize the Capture Settings. (Up to three patterns can be stored.)

The following [ Capture Settings] (P.26) are available.

Image Size	Image Quality	Flash Mode
Drive Mode	AE Metering Mode	Auto rotate
Image with Sound	Color Mode	Color Space
Auto Bracketing Order	Picture Settings	
Half Pressed AEL	◆ ◀▶ Key arrangement	
AEL Button Settings		

SAVE MY SETTINGS

1

Set the above [ Capture Settings] (P.26) to your desired combination.

2

In [ Capture Settings] (P.26) → [Save My Settings], select from **A**, **B** or **C** by using the ◀▶ button. After selecting, press the **OK** button to save the settings.

WARNING !!

- When the new setting is saved, the previous stored setting will be overwritten.

LOAD MY SETTINGS

In [ Capture Settings] (P.26) → [Load My Settings], select from **A**, **B** or **C** by using the ◀▶ button and press the **OK** button.

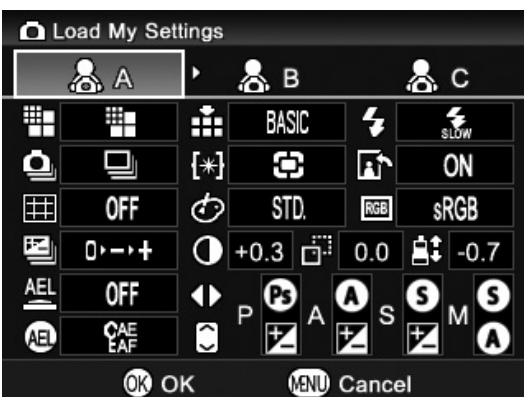

- It is possible to display the details of the setting by selecting the desired pattern.

EXP. KEY ARRANGEMENT

The ◀▶ button and the ⏏ button are used for changing the aperture value, shutter speed and exposure compensation. It is possible to change the function of them for each Exposure Mode.

It is possible to set from [📷 Capture Settings] (P.26) → [◀▶⏏Key arrangement].

Select the desired Exposure Mode by pressing the ◀▶ button and change the function by using the ⏏ button. To apply the setting, press the Ⓞ button.

- To reset to the default setting, select [Reset] by pressing the ◀▶ button and then press the Ⓞ button.

Explanation of the display of [◀▶⏏Key arrangement]

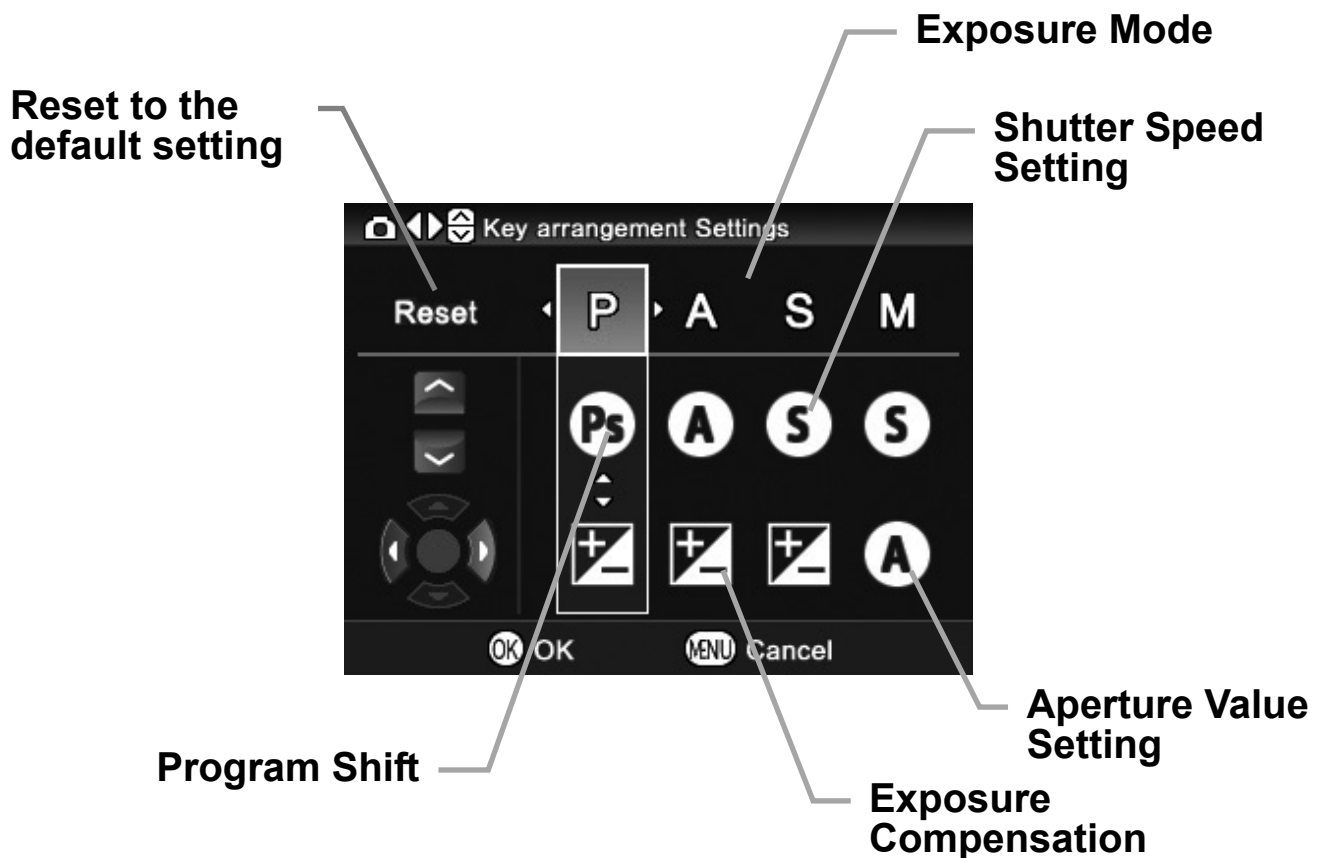

REVIEWING AND DELETING IMAGES

This section explains how to review and delete images after they have been captured.

TIP

- The DP2 may not be able to display images captured by other cameras, or “DP2” images that have been renamed or moved from the **DCIM** folder on the card.

QUICK PREVIEW

The DP2 camera can be set to automatically display a preview of each image immediately after it is taken. This is useful for instantly checking exposure and framing.

CHANGING THE QUICK PREVIEW DURATION

The Quick Preview image can be completely disabled, if you select ‘Off’, or displayed for 2, 5, or 10 seconds.

The Quick Preview Duration can be set from [ **Capture Settings**] (P.26) → [**Quick Preview**].

QUICK PREVIEW OPTIONS

Off	No preview image is displayed.
2 sec.*	Preview image is displayed for 2 seconds.
5 sec.	Preview image is displayed for 5 seconds.
10 sec.	Preview image is displayed for 10 seconds.

TIP

- To manually turn off the Quick Preview image, press the shutter button half-way.
- It will not be possible to zoom in to the preview image, or change to another image while the Quick Preview is up.

REVIEWING IMAGES

The pictures captured by the DP2 can be reviewed in various ways.

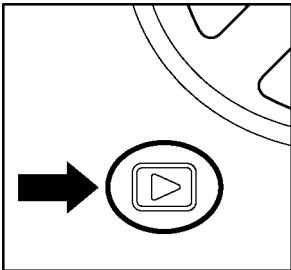

To review images captured by the DP2 camera press the  button on the back of the camera. The last image recorded on the card will be displayed on the color LCD monitor.



Press the  button to display an image on the color LCD monitor.

Press the  button again to change to shooting mode.



TIP

- Even if the camera is switched off, images can be reviewed by pressing and holding the  button for 2 seconds.
- If no new images have been captured, the last reviewed image will be displayed.
- If there are no images on the card, an error message “**No images on Memory card**” will be displayed.
- When reviewing images, if the  button is pressed or the shutter button is pressed “half-way”, the DP2 will be changed back to shooting mode.

VIEWING ONE IMAGE AT A TIME



Press the  button on the back of the camera to see the recorded images in Single-Image View.

WHILE IN SINGLE-IMAGE VIEW:

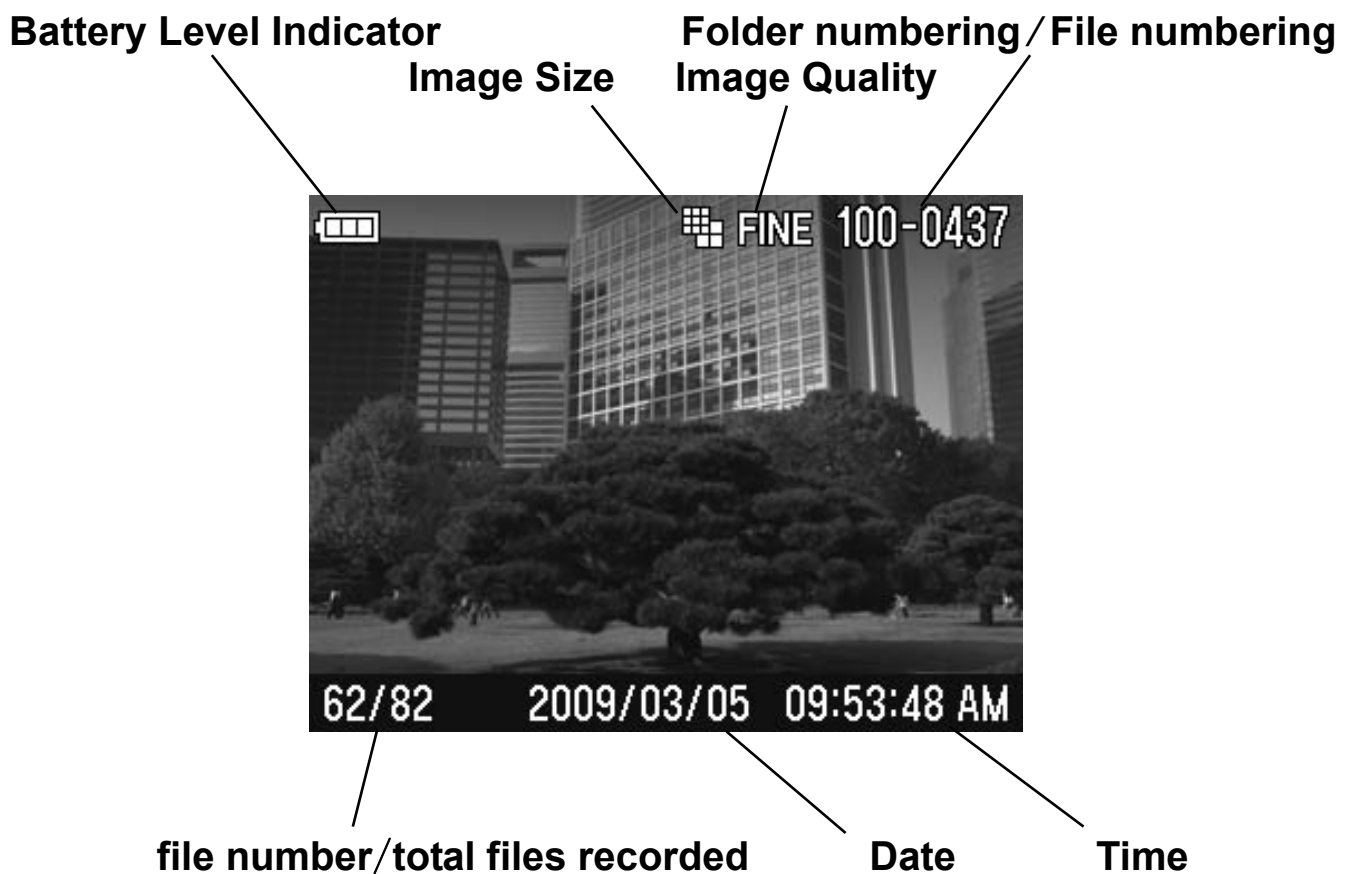
- Press the  button to see the next image.
- Press the  button to see the previous image.



TIP

- To scroll through images more quickly, press and hold a button on the 4-way controller. Images will advance automatically until the button is released.
- The first and last recorded images on the card are linked. Pressing the  button while the first image is displayed brings up the last recorded image on the card. Pressing the  button while the last image is displayed brings up the first recorded image on the card.

MAGNIFYING IMAGES (ZOOMED-IN VIEW)

Reviewed images can be magnified, making it possible to check image details and focusing.

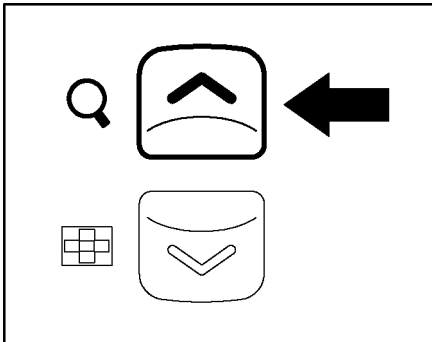





While reviewing images, press the  button.

The magnification ratio will be changed as follows.

Original → **X1.25** → **X1.6** → **X2.0** → **X2.5** → **X3.15** → **X4.0** → **X5.0** → **X6.3** → **X8.0** → **X10.0**

WHILE IN ZOOMED-IN VIEW:

- Press the  button to increase magnification.
- Press the  button to decrease magnification.
- Press the  button or the  button to pan around the image.
- Press the **MENU** button to return to the original ratio.

TIP

- While in Zoomed-In View, the 4-way controller cannot be used to change images. Press the  button or return to the original ration (Single-Image View) by pressing the **MENU** button, then use the 4-way controller to change images.

VIEWING NINE IMAGES AT A TIME (CONTACT SHEET VIEW)

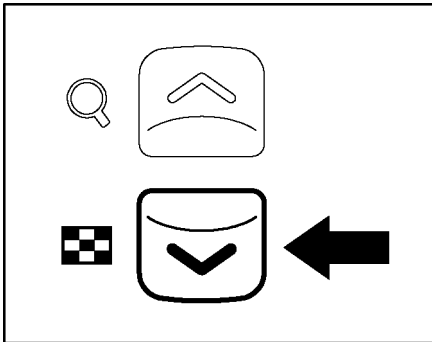

Images can be viewed in a "contact sheet" of nine thumbnail images.



While reviewing images, press the  button.



WHILE IN CONTACT SHEET VIEW:

- Press the  buttons to change the image selection.
- Press the  button to return to Single-Image View.
- Press the  button to go to Jump Mode.

VIEWING IMAGES A PAGE AT A TIME (JUMP MODE)



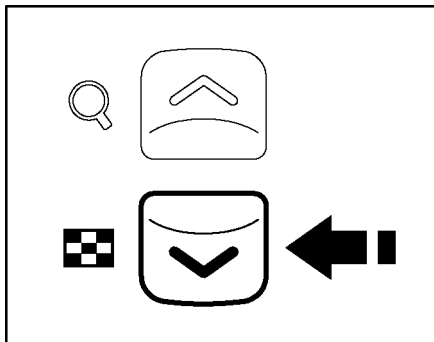

Use Jump Mode to browse large sets of images more quickly, or to skip right to the first or last page of images on the card.





Press the  button twice from Single-Image View (or once from Contact Sheet View).



WHILE IN JUMP MODE:

- Press the  button to jump to the next page of images.
- Press the  button to jump to the previous page of images.
- Press the  button to jump to the last page of images.
- Press the  button to jump to the first page of images.
- Press the  button to return to Contact Sheet.

TIP

- The first and last pages of images are linked. Pressing the  button while the first page of 9 images is displayed brings up the last page of images. Pressing the  button while the last page of images is displayed brings up the first page of images.

VIEWING IMAGES WITH SOUND

Play sounds that have been recorded with Images (P.68) or play the voice memo function (P.97).



1

When the image with sound is selected during image review, the  icon and the Control Icons are displayed on the color LCD monitor.

2



Press the  button to play the recorded sound.

Press the  button to stop the sound.

WARNING !!

- It is not possible to play the recorded sound when the camera is in Zoomed-In View, Contact Sheet View or Jump Mode.

TIP

- The playback volume is set by Set Up menu, however, it is possible to adjust the volume directly. During playback, press the  button to turn the speaker down or the  button to turn the speaker up.
- The sound recording (.WAV file) that is attached to the still image will be stored in the same folder and have the same file name as the image file. For example, the image file name will be SDIM0010.JPG and sound file name will be SDIM0010.WAV. When reviewing the files with your PC it is not possible to open still image and sound image at same time. Please open "WAV" file with dedicated software.

VIEWING IMAGE INFORMATION

The Image Info Screen contains additional information about each image.

Press the  button several times from the Single-Image or Zoomed-In View.

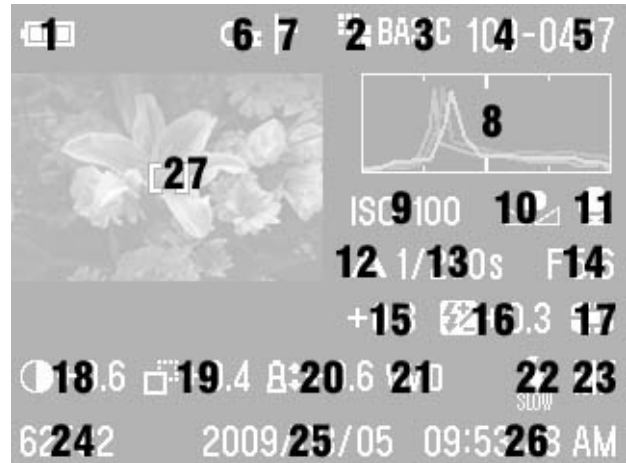
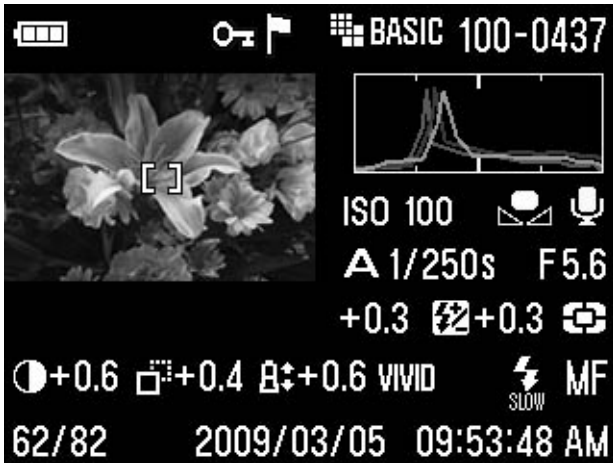



1	Battery Level Indicator
2	Image Size
3	Image Quality
4	Folder numbering
5	File numbering
6	Lock *
7	Mark *
8	Histogram
9	ISO Sensitivity
10	White Balance
11	Image With Sound *
12	Exposure Mode
13	Shutter Speed
14	F Number

15	Exposure Compensation Value*
16	Flash Exposure Compensation Value* / (Auto Bracket *)
17	Metering Mode
18	Contrast *
19	Sharpness *
20	Saturation *
21	Color Mode*
22	Flash Mode *
23	Focus Mode
24	File Number / total files recorded
25	DATE
26	TIME
27	Focusing Frame

*If these features are set, the icon will be displayed.

WHILE IN IMAGE INFO SCREEN:

- Press the  button again to return to the original Single-Image View.
- Different images can be selected in Single-Image View by pressing .

WARNING !!

- It is not possible to select different images while in Zoomed-In View. Press the **MENU** button or the  button to return to the original ratio, then it is possible to select different images.

IMAGE INFO SCREEN FOR MAGNIFIED IMAGES

It is possible to obtain detailed histogram information for a particular section of an image by opening the Image Info Screen from Zoomed-In View.

- For more information on the histogram see next section.

TO DISPLAY MAGNIFIED IMAGE INFO SCREEN

1





Magnify the image to the desired level and pan to the area of interest. (See P.78)

2

Press the  button twice.

The magnified segment of the image will be shown in the thumbnail and the values displayed in the histogram will correspond to that segment only.

WHILE IN IMAGE INFO SCREEN FOR A MAGNIFIED IMAGE:

- Press the  button to pan to another part of the image. (Histogram will update automatically to reflect the new values.)
- Press the  button to decrease magnification or the  button to increase magnification.
- Press the **MENU** button to return to the original Image Info Screen.
- Press the  button to return to Single-Image View.
- Press the  button a second time to view the image without any further information displayed.

HISTOGRAM

The histogram is a graph depicting the distribution of brightness values in the image for each of the three color channels (Red, Green, and Blue) (The histogram displayed in the Shooting Mode is the distribution of tones in the image). The horizontal axis shows the brightness level, with darker pixels towards the left side and brighter pixels toward the right. The vertical axis shows the proportion of pixels at each level of brightness.

By examining the histogram of the full image, you can gauge the overall exposure of that image. You can also use the histogram to determine if zoomed-in sections of an image are over or under exposed.

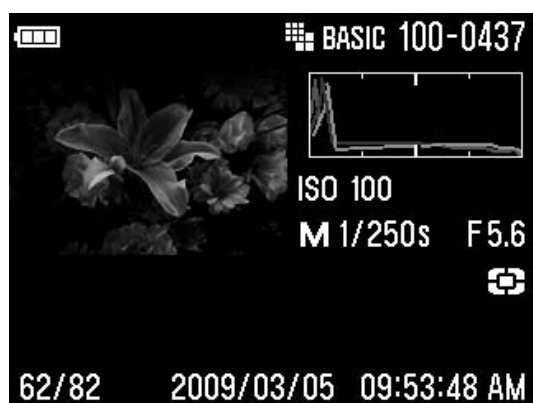

This histogram shows that the higher pixel values are never used in the image, indicating that the image is underexposed, and therefore will appear dark. In general, when the histogram is higher on the left side, the image is mostly composed of dark pixels, causing it to appear dark—either because the image is underexposed or because it is a dark scene such as night shot or sunset.

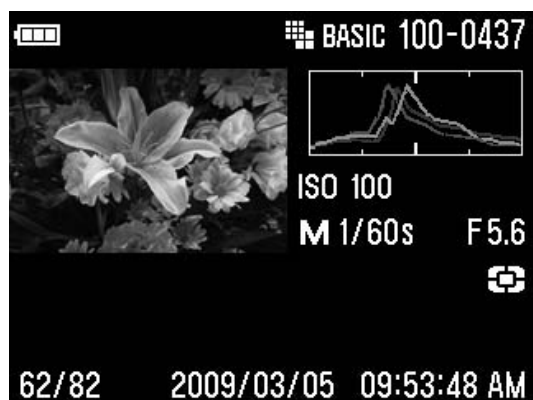

This histogram shows a fairly even distribution of pixel values, indicating that the image is well exposed, with good contrast. However, the histogram distribution of a well exposed image will vary greatly depending on the subject.

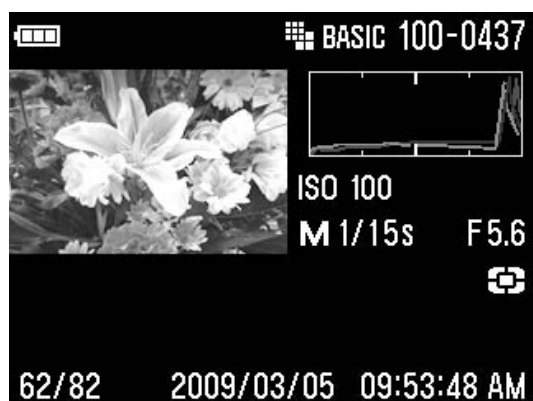

This histogram shows that many of the pixel values are at their brightness limit, indicating that some areas of the image may be blown out. In general, when the histogram runs off the right side, the image will have many white pixels—either because the image is overexposed or because it is a bright scene such as the beach or snow.

VIEWING IMAGES ON A TV

The DP2 camera can be connected to a television or a video device using the provided AV cable, allowing the recorded images to be viewed on the television monitor or recorded on video recording media.

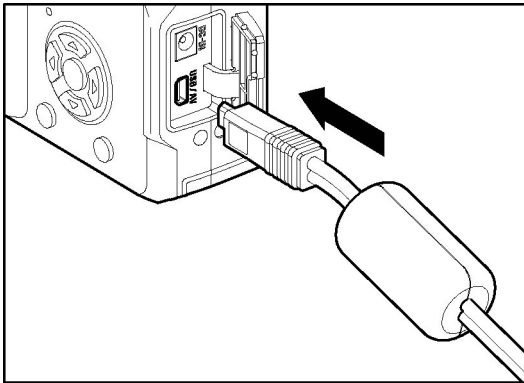

TO CONNECT THE CAMERA TO A VIDEO DEVICE

1

Open the connector cover.

2

Connect the AV cable to the <USB / AV> terminal on the camera body.

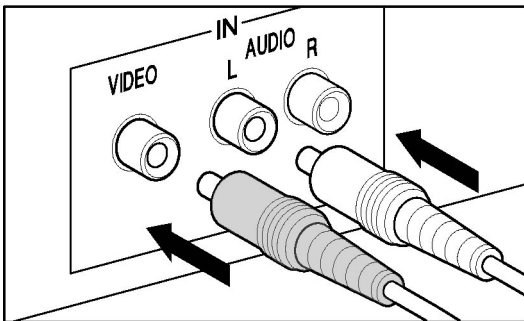

3

Connect the yellow AV cable plug into the video input terminal and the white plug into the audio terminal of the TV

4

Turn on the camera and video device.

WARNING !!

- Please do not use any video cable other than the one provided with your Sigma DP2 camera. Using other brands may cause damage.

TIP

- It is recommended that the camera be powered with the AC adapter (optional) during television playback to avoid draining the battery.
- The default mode for the video signal is NTSC. When connecting the camera to a PAL device, the Video Mode setting in the Camera Set-up menu must be changed. (See **P.112**)

DELETING FILES

This section describes how to delete the files recorded on a card.

Files recorded on the card can be deleted one at a time or several at once using the Delete Menu.

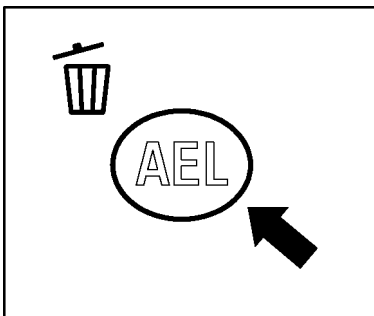

WARNING !!

- This chapter refers to still images, sound and movie files.
- Files cannot be deleted in Jump Mode.



TO DISPLAY THE DELETE MENU

Press the  button while the file you want to erase is displayed.

- If you wish to cancel deleting press the  button once again or select [Cancel] by pressing the  button and then press .

DELETE MENU

Current File	Delete the currently selected image only.
All marked	Delete all marked images on the card. (See P.92 - 94 for information on marking images.)
All	Delete all images on the card. (Locked images are not deleted) (See P.89 - 91 for information on locking images.)
Cancel	Cancel the operation.

DELETING A SINGLE FILE

TO DELETE A SINGLE FILE

1

Use the ◀▶ button to select the file to be deleted in Contact Sheet or Single-Image View.

2



Press  to display the Delete Menu.

- [Current File] will be the default selection.

3

Press the  button to delete the file.

WARNING !!

- If the file is not locked, it will delete the file without asking for confirmation.
- If the file is locked, the message “**This file is locked. Delete anyway?**” will be displayed. If you really wish to delete the file, press the ◀▶ button then select [Yes] and press the  button. If you do not want to delete the file, select [No] and press  button.

DELETING MULTIPLE FILES

TO DELETE MULTIPLE FILES

1

Pressing the  button will open the delete menu

2



Select [**All Marked**] or [**All**] by using the  button.

- Locked images will not delete. To delete these images, please unlock them before deleting (See **P.89 - 91** for information).

3

Press the  button to display the confirmation dialog.

4

To delete all files, select [**Yes**] by using the  button and press the  button.

If you do not wish to delete the images, select [**No**] and press  the button.

WARNING !!

- When [**All marked**] or [**All**] is done, it may take time to finish them depending on the number of files in the card.
- Locked and Marked images will not be deleted when [**All Marked**] is selected. Locked images must be unlocked first. Marked images are not protected from deletion unless they are also locked.

OTHER REVIEWING FEATURES

This section explains how to use Slideshow, Lock, Mark, Rotate and so on.

LOCKING FILES

Locking protects files from being accidentally deleted.

LOCK MENU

Lock	Lock the currently selected file.
Unlock	Unlock the currently selected file.
🚩 Lock all	Lock all marked files on the card. (See P.92 -94 for information on marking images.)
🚩 Unlock all	Unlock all marked files on the card. (See P.92 -94 for information on marking images.)
Lock all	Lock all files on the card.
Unlock all	Unlock all locked files on the card.

WARNING !!

- It is not possible to lock a file when the camera is in Jump Mode.

CAUTION !!

- Locking does not prevent files from being erased when the card is formatted. Review card contents carefully before formatting.

TIP

- Locked files have a “read-only” status when viewed on a computer.

TO LOCK A SINGLE FILE

1

Use the ◀▶ button to select the file to be locked in Contact Sheet or Single-Image View.

2

Open [▶ Playback Menu](P.26) by pressing the MENU button and select [Lock].

3

In Open Display, select [Lock] by pressing the ◀▶ button and press the OK button.

4

Close [▶ Playback Menu] by pressing the MENU button.



- A key icon will appear in the upper-right corner of the file indicating the file is locked.

UNLOCKING A SINGLE FILE



To unlock a locked file, select the locked file, then select [Unlock] in step 3 and press the OK button.

TO LOCK MULTIPLE FILES



1

Open [ **Playback Menu**](P.26) by pressing the **MENU** button and select [**Lock**].

2

In Open Display, select [ **Lock all**] or [**Lock all**] by pressing the  button and press the  button.

3

When the confirmation message is displayed, select [**Yes**] by pressing the  button and press the  button to apply the setting.

4

Close [ **Playback Menu**] by pressing the **MENU** button.

- A  icon will appear in the upper-right corner of the file indicating that all files are locked.



To dismiss Lock, select [**No**] and press the  button.

UNLOCKING MULTIPLE FILES

1



Select [ **Unlock all**] or [**Unlock all**] and press the  button in step **2**.

2

When the confirmation message is displayed, select [**Yes**] by pressing the  button and press the  button to apply the setting.

To dismiss Unlock, select [**No**] and press the  button.

WARNING !!

- When [ **Lock all**] or [ **Unlock all**] is done, it may take time to complete this depending on the number of files in the card.

MARKING IMAGES

Images can be marked for various reasons, such as to identify favorites, to select images for a Slideshow, or to select images to be deleted with the “All marked” menu item in the Delete Menu (P.88).

MARK MENU

Mark	Mark the currently selected image.
Unmark	If the currently selected image is already marked, the image will be unmarked.
Mark all	Mark all images on the card. (If all images on the card are already marked, this option will not be available.)
Unmark all	Unmark all marked images on the card.

WARNING !!

- It is not possible to mark a sound memo and movie.
- It is not possible to mark a file when the camera is in Jump Mode.

TIP

- Images marked on the camera will retain their marked status when viewed in **SIGMA Photo Pro**.

TO MARK A SINGLE IMAGE



1

Use the  button to select the image to be marked in Contact Sheet or Single-Image View.

2

Open [ Playback Menu](P.26) by pressing the MENU button and select [Mark].

3

In Open Display, select [Mark] by pressing the  button and press the  button.

4

Close [ Playback Menu] by pressing the MENU button.



- A  icon will appear in the upper-right corner of the image indicating that the image is marked.

UNMARKING A SINGLE FILE

To unmark a marked image, select the marked image then select [Unmark] in step **3** and press the  button.

MARKING ALL IMAGES

1

Open [**▶ Playback Menu**](P.26) by pressing the **MENU** button and select [**Mark**].

2

In Open Display, select [**Mark all**] by pressing the **◆** button and press the **OK** button.

3

When the confirmation message is displayed, select [**Yes**] by pressing the **◀▶** button and press the **OK** button to apply the setting.

4

Close [**▶ Playback Menu**] by pressing the **MENU** button.

- A  icon will appear in the upper-right corner of the image indicating that all images are marked.

To dismiss Mark, select [**No**] and press the **OK** button.

UNMARKING MULTIPLE IMAGES

1

Select [**Unmark all**] in step **2** and press the **OK** button.

2

When the confirmation message is displayed, select [**Yes**] by pressing the **◀▶** button and press the **OK** button to apply the setting.

To dismiss Unmark, select [**No**] and press the **OK** button.

WARNING !!

- When [**Mark all**] or [**Unmark all**] is done, it may take much time to finish them depending on the number of files in the card.



ROTATING IMAGES

It is possible to rotate the displayed image. The images' new orientation will be used in all views as well as in the Slideshow.

TIP

- Images rotated on the camera will be displayed in their rotated orientation in SIGMA Photo Pro.
- Movie cannot be rotated.

ROTATE MENU

Rotate 	Rotate the currently selected image 90 degrees to the left (counterclockwise).
Rotate 	Rotate the currently selected image 90 degrees to the right (clockwise).

1

Use the  button to select the image to be rotated in Contact Sheet or Single-Image View.

2

Open [ **Playback Menu**](P.26) by pressing the **MENU** button and select [**Rotate**].

3

In Open Display, select the desired direction of rotation by pressing the  button.

4

Close [ **Playback Menu**] by pressing the **MENU** button.

TIP

- To rotate an image 180 degrees, rotate it twice in the same direction.
- To get an image back into its original orientation, rotate it in the opposite direction.
- If the Rotate Menu was opened from Jump Mode, both “Rotate” menu items will be unavailable.

EXPOSURE WARNING

It is possible to indicate the over-exposed areas by highlighting them in red.

Set to **[On]** from [**▶ Playback Menu**] (P.26) → **[Exposure Warning]**.

- The Exposure Warning is not indicated in the Quick Preview.

To dismiss the Exposure Warning, set to **[Off]** from [**▶ Playback Menu**] (P.26) → **[Exposure Warning]**.

OK BUTTON SHORTCUT

It is possible to allocate a function from the Playback Menu to the **OK** button. The allocated function can be changed by pressing the **OK** button.

The OK Button Shortcut can be set in [**▶ Playback Menu**] (P.26) → **[OK Shortcut]**.

Available functions to allocate to the **OK button.**

Lock/Unlock	Lock the currently selected image by pressing the OK button. If the current image is already locked, the image will be unlocked.
Mark/Unmark	Mark the currently selected image by pressing the OK button. If the current image is already marked, the image will be unmarked.
Exp. Warning	Each time the OK button is pressed, toggle the exposure warning on or off.
Rotate ↺	Each time the OK button is pressed, rotate the currently selected image 90 degrees to the left (counterclockwise).
Rotate ↻	Each time the OK button is pressed, rotate the currently selected image 90 degrees to the right (clockwise).

To dismiss the allocated function, set to **[None]** from [**▶ Playback Menu**] (P.26) → **[OK Shortcut]**.

RECORDING SOUND MEMO

It is possible to record a sound memo for 10 seconds or 30 seconds to a stored image, making it convenient to record the shooting situation by voice.

1

Open [▶ Playback Menu](P.26) by pressing the **MENU** button and select [Sound Memo].

2

In Open Display, select the desired number of seconds by pressing the ◀▶ button and press the **OK** button.

3

Close [▶ Playback Menu] by pressing the **MENU** button.



- The microphone icon, selected seconds and Control Icons are displayed on the color LCD monitor.

4

Press the ▲ button to start the recording. (The recording can be for up to the selected seconds.)

If the ▲ button is pressed during the recording, the recording will be terminated.



To play the recording sound memo, press the ▼ button. (See P.81 for instruction of Viewing Images With Sound.)

WARNING !!

- The sound memo function will not be disabled if it is not cancelled. Pressing the ▲ button will activate it each time and a new sound file will overwrite the existing file. To prevent this, please press [**Cancel**] after completeing the “recording sound memo” function.

TIP

- The recorded data will be stored as a WAV file. It will be stored in the same folder with as a separate file but same file number as image file. For instane file name will be SDIM0010.JPG and sound file name will be SDIM0010.WAV.

SHOWING A SLIDESHOW

All images on the card, or only selected images, can be shown in automatic playback mode using the DP2 camera's Slideshow feature.

SLIDESHOW MENU

Show all	Start an automated slideshow of all images on the card.
Show locked	Start an automated slideshow of all locked images on the card.
Show marked	Start an automated slideshow of all marked images on the card.

WARNING !!



- When viewing a slideshow, only first frame of a movie file will be displayed. Audio files will not be played.

TO START A SLIDESHOW

1

Open [ **Playback Menu**](P.26) by pressing the **MENU** button and select [**Slideshow**].

2

In Open Display, select [**Show all**], [**Show locked**] or [**Show marked**] by pressing the  button. A Slideshow can be started by pressing the  button.

To terminate the slideshow, press the  button. Then press the **MENU** button to close the Slideshow menu.



WARNING !!

- When 「**Show marked**」 is selected, it may take time to start the Slideshow depending on the number of files to be displayed.

NOTE

- When the slideshow is stopped, the last image will continue to be displayed.



CHAGING SLIDESHOW SETTINGS

In Open Display of [Slideshow], select the [Slideshow Settings] by pressing the  button, then press the  button to jump to the Slideshow Setting menu.

SLIDESHOW SETTING MENU

Duration	2 sec.* 5 sec. 10 sec.	Set the length of time that each image in a slideshow is displayed.
Repeat	No* Yes	Set whether the slideshow loops continuously or stops on the last image.

Duration

Select [Duration] using the  button, then select the desired number of seconds by pressing the  button.

Repeat

Select [Repeat] using the  button, then select [No] or [Yes] by pressing the  button.

RECORDING AND PLAYING BACK MOVIES

RECORDING MOVIES

It is possible to record movies with sound.

- The image size is QVGA (320X240) (Image area is 320X212, black stripes are recorded up and down).
- The number of shooting frames per second (frame rate) is 30 frames.
- The movie will be stored as an AVI file. (For instance, file number 0023 will be SDIM0023.AVI.)



Available recording time counter

Elapsed time counter

1

Set the Mode Dial to the  position.

2

Press the shutter button to start recording the movie. (During recording, the  icon and the busy lamp will blink.)

3

To terminate recording, press the shutter button again.

- When the focus mode is set to AF, the focus will be locked by pressing the shutter button “half-way”. During movie recording, the focus will remain locked.

- When the focus mode is set to MF, the focus will be locked to the position set by the MF Dial when pressing the shutter button. During movie recording, the focus will remain locked, even if the MF Dial is rotated.
- It is possible to change the white balance setting (**P.53 - 55**).

The recording capacity of cards is as shown below.

512MB	1GB	2GB	4GB
15 min	30 min	60 min	120 min

WARNING !!

- The camera's operation sound might be recorded while shooting the movie.
- The available recording time is dependent on the size of the SD card used. It is also possible that recording might be terminated during shooting due to the capacity of the card in use.
- The maximum recording data size for one movie shoot is 2GB. The recording will be terminated automatically when the recording data size exceeds 2GB.
- The recording will be terminated when the battery power is insufficient.
- The remaining time display might not change constantly because it is calculated from the capacity of the card while shooting.
- The remaining time display can show a maximum of 99 min. 59 sec. If a large capacity card is used, the remaining time counter will not change from 99:59 until the recording time is 99min: 59 sec. or less.
- Custom white balance cannot be captured in Movie Mode. If you wish to use custom white balance, please capture it in still image mode and then change the camera back to Movie Mode.

PLAYING BACK MOVIES

How to playback movies.

1

When movie playback is selected, the first one frame of the movie is displayed as a still picture. The control icons are displayed on the bottom right of the movie playback screen.

2



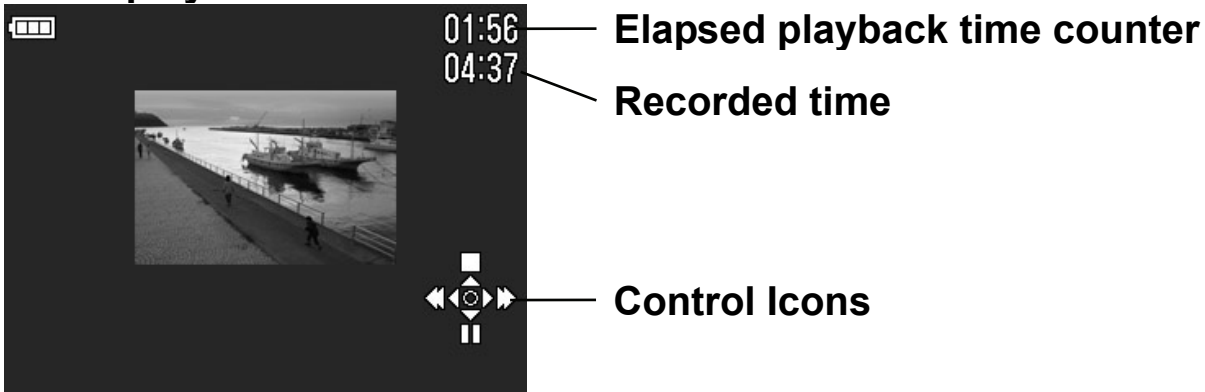

Press the  button to playback the movie.

Movie playback screen

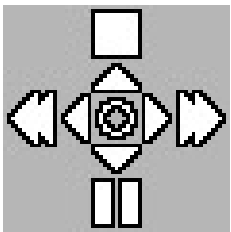





Movie play back screen...



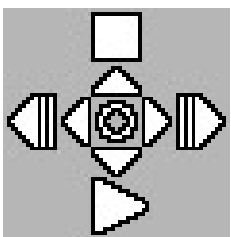

- Press the  button to terminate playback.
- Press the  button to pause playback.
- Keep pressing the  button to fast-forward.
- Keep pressing the  button to fast-rewind.

When “pause” is selected...



- Press the  button to terminate playback.
- Press the  button to restart playback.
- Keep pressing the  button to play in slow motion.
- Keep pressing the  button to rewind in slow motion.

TIP

- Although sound volume can be set from the [ **Camera Settings**] (P.26) → [**Sound Settings**] → [**Sound Volume**], it is also possible to adjust the volume during playback. Pressing the  button will decrease the volume, and pressing the  button will increase the volume.
- After transferring the files to your PC, please play AVI files with dedicated software.

RECORDING AND PLAYING BACK SOUND

RECORDING SOUND (VOICE RECORD MODE)

It is possible to use the DP2 as a sound recorder.

- A sound file will be stored as a WAV file. (For instance, file number 0023 will be SDIM0023.WAV.)

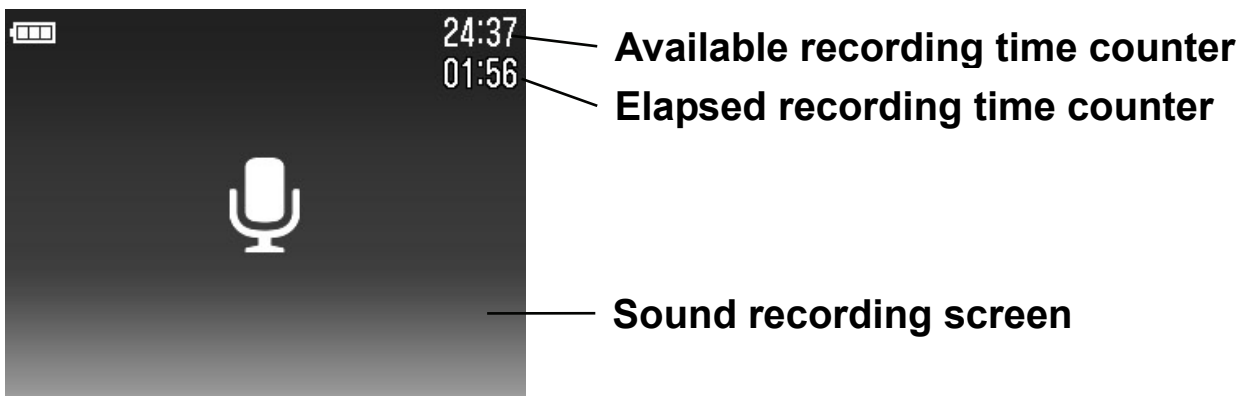

1

Set the Mode Dial to the  position. (The sound recording screen will be displayed)

2

Press the shutter button to record sound. (During recording, the busy lamp will blink.)

3

Press the shutter button again to terminate the recording.

WARNING !!

- The available recording time is dependent on the capacity of the card.
- The available recording time display may not change constantly because it is calculated from the capacity of the card while recording.

The recording capacity of cards is as shown below.

512MB	1GB	2GB	4GB
178 min	356 min	712 min	1424 min

PLAYING BACK SOUND

How to playback sound recorded in the sound recording mode.

1

When playback of sound is selected, the sound recording screen will be displayed. (The operation icons will be displayed on the bottom right of the display.)

2

Press the ▼ button to playback the sound recording.

Sound playback screen

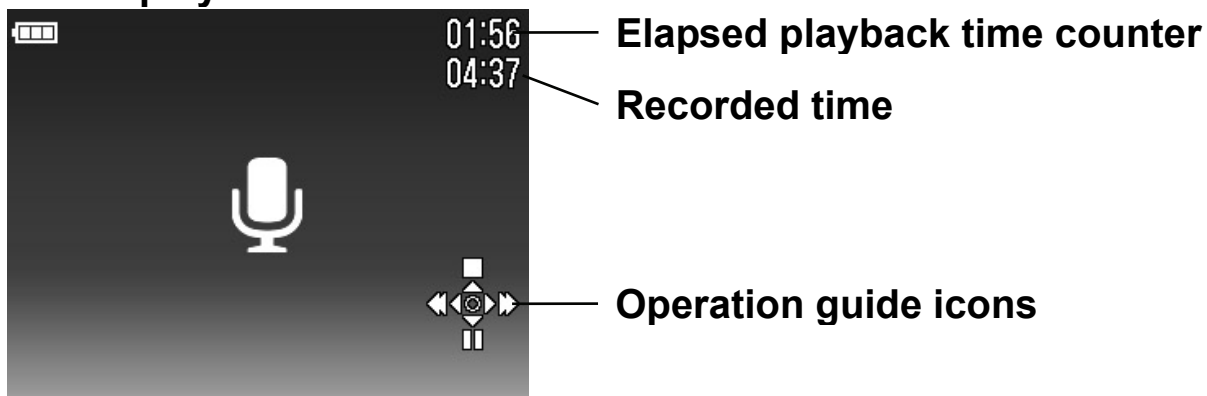

When playing the sound ...

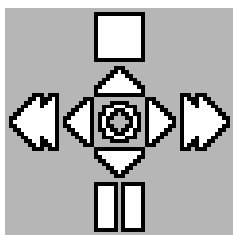

- Pressing the ▲ button will stop playback.
- Pressing the ▼ button will pause playback.
- Pressing the ► button will fast-forward.
- Pressing the ◀ button will fast rewind.

TIP

- Although sound volume can be set from the [**Camera Settings**] (P.26) → [**Sound Settings**] → [**Sound Volume**], it is also possible to adjust the volume during playback. Pressing the ▼ button will decrease the volume, and pressing the ▲ button will increase the volume.
- After transferring the files to your PC, please play WAV files with dedicated software.

PRINTING IMAGES

This section explains how to print images (JPEG data) captured by a DP2, without the need of a PC. It is not possible to print RAW data (X3F file) directly with the PictBridge Standards. To print RAW format images, it is necessary to change the RAW file (X3F) to JPEG by using image processing software such as “SIGMA Photo Pro” on your PC. See the **SIGMA Photo Pro** instruction manual for more information.

PRINTING IMAGES WITH PICTBRIDGE COMPATIBLE PRINTERS

It is possible to print your pictures without a PC by connecting the DP2 to a PictBridge compatible printer using the supplied USB cable.



1

Set the Mode Dial to the **SET UP** position and set [ **Camera Settings**] (P.26) → [USB Mode] → [PictBridge].

2

Turn the printer on and confirm that it is ready for printing. Connect your camera to the printer with the supplied USB cable.

3

After connecting, the “Select Images & Quantity” menu (table A. below) will appear. Press the  buttons and select the desired option. Stored images in the card will be displayed after pressing the  button.

A. Select Images & Quantity menu

<p>Select / Quantity</p>	<p>This option allows you to select individual images and the number of copies for printing. Select the image that you wish to print by pressing the ◀▶ button. Then select the quantity of prints by pressing the ⬇ button.</p>
<p>Select All Images</p>	<p>This will print all printable still images recorded on the card. Press the ⬇ button to select the number of copies.</p>
<p>Cancel All Selections</p>	<p>This will reset the number of copies that has been previously selected. Select [OK] by using the ◀▶ button. The selection of images and number of copies for printing are reset by pressing the Ⓞ button. The menu then returns to Select Image & Quantity menu.</p>
<p>Apply DPOF Settings (If DPOF setting is not applied, it is not possible to select it.)</p>	<p>It is possible to select the printing quantity of [DPOF] from [▶ Playback Menu]. (P.109)</p>

WARNING !!

- If no card is inserted into the camera, [No Memory Card] message will be displayed.
- If the card contains still images which cannot be printed, [No images on Memory card] will be displayed.
- If [Printer error! Please check the printer.] message is displayed, please check your printer and ensure that it is correctly setup and connected.
- It is not possible to print RAW images (files with the X3F extension).
- Some printers do not include a DPOF setting, therefore it is not possible to select [Apply DPOF Settings] with such printers.

4

After selecting the images and quantity, press the **MENU** button to display Printing Setting menu (table **B.** below). Select the desired menu by using the  button and set the details in each Open Display.

B. Printing Setting menu

Print Size	[Apply Printer Settings] or Card / 3.5 x 5 in. / 5 x 7 in. / Hagaki / 4 x 6 in. / A4 can be selected.
Date Print	[Apply Printer Settings] or Without Date / With Date can be selected.
Layout	[Apply Printer Settings] or Without Margin / With Margin / 2 up / 4 up / Index Print can be selected.

5

After setting each option, press the **MENU** button to return to reviewing images. Then press the **QS** button to start the printing.

- It will return to the Select Images & Quantity menu when the printing ends.

WARNING !!

- Printing cannot proceed correctly if the printer doesn't correspond to the above-mentioned printing settings, and the specified size format is not set.
- Please do not remove the USB cable until printing is complete.
- If you wish to cancel printing please do so from the printer.

DPOF (DIGITAL PRINT ORDER FORMAT)

When printing images at a photo lab, it is possible to specify which photos and quantity to print in advance, using the DPOF menu. This is also available when making prints using a DPOF compatible printer.



WARNING !!

- In the case of RAW images (files with X3F extension), DPOF printing is not possible.









1

When the still image is reviewed, open [ **Playback Menu**] (P.26) by pressing the **MENU** button and select [**DPOF**].

2

In Open Display, select the desired options by using the  button and press the  button.

DPOF MENU

Select / Quantity	Set the print quantity by pressing the  buttons. To set number of copies from multiple images, select the image that you wish to print by pressing the  buttons and then set the print quantity for each image by pressing the  buttons. Press the  button to apply the setting.
Select All Images	This option selects all still images on the card for printing. Set print quantity by pressing the  buttons and press the  button to apply the setting.
Cancel All Selections	Reset all print quantity settings. Press the  buttons to select [OK] and press the  button to cancel all print quantity settings.

TIP

- Total number of print quantity (the total sum of print quantity for each image) is displayed at the lower right of the monitor.

REFERENCE

OPTIONAL ACCESSORIES

ELECTRONIC FLASH EF-140 DG SA-STTL

This compact design flashgun has a maximum Guide Number of 14 (ISO100 / m). Please see **P.69** for more information.

VIEW FINDER VF-21

This high performance Albada inversed Galilean type Finder mounts on the hot shoe. It offers a framing guide for deciding the composition without the color LCD monitor and accurate framing unaffected by external light condition.

HOOD ADAPTER HA-21

This lens hood blocks out extraneous light and reduces flare and ghosting. A hood adapter for attachment to the camera body is included. It is designed to accept a 46mm lens filter.

AC ADAPTER SAC-3

This is used to provide a constant electricity supply and is recommended when taking indoor shots or connecting the camera to your computer to transfer data. (**P.23**)

MAINTENANCE

- Do not use chemicals or other cleaning agents such as thinners or benzene for cleaning the camera and lens. Use a clean, soft cloth and blower to clean the camera and lens. Lens cleaners can be used for removing fingerprints.
- Do not lubricate the camera.
- Use a blower to remove dust and dirt from the color LCD monitor. To remove fingerprints or other stains from the LCD monitor, wipe the surface gently with a soft, clean cloth. Do not apply excessive force, as this could damage the LCD monitor.

EXPLANATION OF TERMS

AE

Auto Exposure; by using a built-in exposure meter, the camera determines the correct exposure value, which is a combination of shutter speed and aperture value.

AE Lock

The camera will fix and memorize the exposure value with AE lock. For example, if a photographic subject is placed in the center and exposure value of the composition is fixed, the brightness of the background will not influence the exposure, even if the composition changes and the subject is moved from the center of a screen. (AE lock button must be used).

AF

Auto Focus; by using a built-in sensor, camera adjusts the focusing automatically.

AF Lock

In AF shooting mode, you can lock the focus on the main subject. For instance, compose the desired subject in the center of the viewfinder. With the focus fixed at the same setting, you can re-compose the picture with the subject off-center and take pictures. (Please press the shutter button "Half-way" to use this feature with the Sigma DP2).

Aperture

The lens opening of the iris diaphragm inside the lens. The amount of light, which strikes the image sensor, is adjusted by the iris diaphragm. The f-number (Focal Length/Diameter of the Aperture Opening) describes the size of this opening, the size of the hole can be made larger or smaller. A large aperture (low f-number) gives bright results and a small aperture (high f-number) gives darker results.

Auto Power-Off

To save battery power, the DP2 camera will automatically turn itself off if it is not used for a period of time.

CMOS

Complementary Metal Oxide Semiconductor (CMOS) can perform signal amplification on a per-pixel basis. Significant current flows only during the switching operation. Therefore a CMOS image sensor can scan data rapidly, sustain high-speed operation and consume less energy. Recent technological and production improvements in digital imaging systems are making CMOS more and more competitive in terms of image quality and cost.

Color Temperature

The numerical expression of the tone of the light, produced by a light source. The standard unit for color temperature is degrees Kelvin (K). The sunny daylight used as a standard near 5600 K. Low color temperature implies warmer more yellow/red light while high color temperature implies a colder more blue light. The typical color temperature of Tungsten light is 3200 K grade, a personal computer is 9300 K.

Exposure.

The amount of light reaching the image sensor's surface. The exposure is controlled by the combination of aperture and shutter speed.

EV

Exposure Value (EV) is a numerical value that expresses the amount of light for a given exposure, and depends on brightness of the photographic subject and sensitivity of the film. If a photographic subject is bright, then this numerical value will be large, and if the subject is dark then this numerical value will be small. If two-times of light reaches the film surface then the difference in exposure value will be +1, and if the amount of light is reduced by half, the exposure value changes by -1.

Histogram

The histogram function is a graphic representation of how bright and dark pixels are distributed in an image. The histogram function enables a precise check on the exposure of the photo.

ISO Sensitivity

ISO (International Organization for Standardization) ; refers to the number assigned to each silver halide film, which indicates film speed or the film's relative sensitivity to light, the higher the number, the greater photosensitivity and vice versa. Digital cameras also use standard ISO sensitivity ratings like silver halide films.

JPEG

Joint Photographic Experts Group has established a standard method for compressing and decompressing the digitized images. If the rate of compression is high the file size will be small but picture quality will be decreased.

NTSC

National Television Standards Committee (NTSC) video format is primarily used in the United States, Japan, Canada etc. The NTSC is a standard for television and videos, which defines a composite video signal with a refresh rate of 60 half-frames (interlaced) per second. Each frame contains 525 lines and can contain 16 million different colors.

PAL

Phase Alternating Line (PAL) video format, primarily used in Europe, excluding France, as well as Australia and parts of the Far East. PAL delivers 625 lines at 50 half-frames per second.

RAW

The RAW image format is the data as it comes directly from the image sensor of the camera. No in-camera processing is performed before transferring the image to computer.

Shutter Speed

The camera's shutter opens for a length of time to control the amount of light that reaches the imaging element. The length of time that shutter blinds are open allowing light to strike the image sensor is called a shutter speed.



White Balance

The human eye and brain adapt to changes in lighting conditions, not only to intensity, but also to the color characteristic of the light source, so that colors of the objects look normal or accurate. For example, a white object will appear white whether it is viewed under sunlight, tungsten or fluorescent illumination. However, color film or digital camera must be adjusted, so that colors will be represented accurately, under different types of illumination. This adjustment is called white balance. The function to adjust a white balance automatically is called automatic white balance.

FILE NUMBERING SYSTEM

Stored data is automatically assigned file numbers from 0001 to 9999. When data is being reviewed, the file number of each image is displayed in the right corner on the color LCD monitor (see **P.77, 82**). The file number is also incorporated into the filename of the image. The filename consists of “SDIM” followed by the 4-digit file number and extension. For example: image number 0023 will be stored in the file SDIM0023.X3F.

All DP2 image files will be stored to ###SIGMA folder of the DCIM folder in the card.

- When [**Adobe RGB**] is selected from [ **Shooting Menu**] (**P.26**) → [**Color space**], the filename will consist of “_SDI” instead of “SDIM”.
- File numbering can be continuous, or can be reset every time an empty card is detected. The File Numbering can be set from [ **Camera Settings**] (**P.26**) → [**File Numbering**].

FILE NUMBERING OPTIONS

Continuous *	Numbering is continuous. The first file number assigned on an empty card will be one higher than the last assigned number. (If the inserted card contains DP2 images with file numbers greater than the last assigned number, file numbering will continue with one higher than the highest file number on the card.)
Auto Reset	Each time an empty card is inserted, or all images on the current card are deleted, the file number will reset to its default value of 0001. (If the inserted card already contains DP2 images, the file number will not be reset).

LCD SLEEP AND AUTO POWER OFF

The DP2 has [**LCD Sleep**] and [**Auto Power Off**] functions in order to conserve battery power.

If not used for a predetermined amount of time, the color LCD monitor or power will be turned off automatically.

LCD Sleep

If not used for a predetermined amount of time, the color LCD monitor will be turned off automatically. During LCD Sleep, press the shutter button “half-way” or any other button to turn the LCD monitor back on.

Auto Power Off

If not used for a predetermined amount of time, the camera will be turned off automatically. To take or review pictures again, it is necessary to turn the camera back on.

LCD Sleep Option

Off
30 sec.
1 min. *
2 min.
5 min.

Auto Power Off Option

Off
10 sec.
30 sec.
1 min.
2 min. *
5 min.

- The LCD Sleep and Auto Power Off can be set from [ **Camera Settings**] (P.26) → [**LCD Sleep**] or [**Auto Power Off**].

TIP

- To disable LCD Sleep, set [**LCD Sleep**] to [**Off**].
- To disable Auto Power Off, set [**Auto Power Off**] to [**Off**].

WARNING !!

- [**Auto Power Off**] setting has priority over the [**LCD Sleep**] setting. When you set [**LCD Sleep**] to [**5 min.**] and [**Auto Power Off**] to [**1 min.**], the camera will be turned off if not used for 1 minute.

TROUBLESHOOTING

If you have a problem with your camera or cannot take good pictures, consult the list below as you check the camera before requesting repairs.

Nothing is displayed on the color LCD monitor.

Battery is exhausted.

- ▶ Replace the battery. (P.19 - 22)

Battery is improperly installed.

- ▶ Insert the battery in the proper direction. (P.20)

LCD Monitor is set to OFF mode.

- ▶ Press the  button to display the color LCD monitor. (P.35)

Camera is in LCD Sleep mode.

- ▶ Press the shutter button “half-way” or any other button. (P.114)

The shutter does not release.

The camera is busy writing to the card.

- ▶ Please wait until the card busy light goes off.

Card is full.

- ▶ Insert a new card or delete unwanted images. (P.86 - 88)

Autofocus does not operate.

Focusing mode is set to MF.

- ▶ Change the focusing mode by pressing the Focus mode button. (P.48)

The camera has turned off automatically.

Auto Power Off is activated.

- ▶ The Auto Power Off function is set in order to conserve battery power. If it is inconvenient, please set the Auto Power Off to “Off”. (P.114)

Cannot shoot or store images.

Card is full

- ▶ Insert a new card or delete unwanted images. (P.86 - 88)

Battery is exhausted.

- ▶ Replace the battery. (P.19 - 22)

The write protection switch is in the ‘LOCK’ position.

- ▶ Please unlock the write protection switch on the card. (P.10)

Image data on the card is corrupted.

- ▶ If important data remains in the card after transferring it to your PC, please format the card. (P.39)

Difficulty seeing the images on the color LCD monitor.

Dust or dirt has adhered to the color LCD monitor.

- ▶ Clean the color LCD monitor with a blower or eyeglass cloth. (P.110)

The color LCD monitor is worn out.

- ▶ Please consult the retailer from which you purchased the camera or contact the nearest Sigma Service Center.

Pictures are coming out blurred

AF may not be activated when the shutter was pressed.

- ▶ Press the shutter button “half-way” and press it after the focusing point is illuminated in green. (P.48)

Focusing mode is set to MF.

- ▶ Change the focusing mode by pressing the Focus mode button. (P.48 - 50)

Camera shake is occurred.

- ▶ Use the flashguns or tripod. (P.46, 47, 69)

Cannot delete images.

Images may be locked.

- ▶ Unlock the images. (P.89 - 91)

Incorrect date and time is shown.

Date and time setting may be incorrect.

- ▶ Enter the correct date and time in the Set-up Menu. (P.25)

No image appears on the TV monitor.

The AV cable is not connected properly.

- ▶ Reconnect the AV cable.

The video terminal (yellow) and the audio terminal (white) are not connected properly.

- ▶ Reconnect the video terminal (yellow) and audio terminal (white) to the correct position. (P.85)

Cannot play-back sound

Sound volume is set 0.

- ▶ Turn the sound volume up by pressing the  button in playing-back movie and sound. (P81, 103, 105)

- ▶ The Sound Volume can be set from [ Camera Settings] (P.26) → [Sound Settings] → [Sound Volume]. (P.32)

SPECIFICATIONS

Image Sensor	FOVEON X3® Direct Image Sensor (CMOS)	
Image Sensor Size	20.7×13.8mm	
Number of Pixels	Total Pixels 14.06MP (2652×1768×3 layers)	
Aspect Ratio	3 : 2	
Lens	24.2mm (35mm equivalent focal length : 41mm))	
Lens F number	F2.8 ~ F14	
Lens Construction	6 Groups, 7 Elements	
Shooting Range	28 cm ~ ∞, 100 cm ~ ∞ (LIMIT mode)	
Storage Media	SD Card / Compatible with SDHC, Multi Media Card	
Recording Format	Exif 2.21, DCF 2.0, DPOF	
File Format	Still image	X3F (Lossless compression RAW data)(12-bit) JPEG (Fine, Normal, Basic)
	Movie	AVI
	Voice	WAV
Image size (Number of Pixels)	Still image	High : 2640×1760 Wide : 2640×1485 Medium : 1872×1248 Low : 1312×880
	Movie	QVGA : 320×240 (Image area 320×212)
White Balance	8 types (Auto, Daylight, Shade, Overcast, Incandescent, Fluorescent, Flash, Custom)	
ISO Sensitivity	AUTO (ISO100~ISO200) (with flashgun ISO100~ISO400) ISO50, 100, 200, 400, 800, (1600, 3200) * ISO1600~3200 in RAW mode only	
Auto Focus	Contrast Detection Type	
AF Point	9-Points (Manual Selection)	
Focus Lock	Shutter release halfway-down position (AF lock can be done by AE lock button from menu setting)	
Manual Focus	Dial Type	
Metering System	Evaluative metering, Center-Weighted Average Metering Spot metering	
Exposure Control System	(P) Program AE, (S) Shutter Priority AE, (A) Aperture Priority AE, (M) Manual	
Exposure Compensation	±3EV (1/3 stop increments)	
AE Lock	AE lock button	
Auto Bracketing	Appropriate, under, over; 1/3EV steps up to ±3EV for appropriate exposure	
Shutter Speed	1/2000-15sec.	
Built-in Flash	Pop-up type (manually), Guide number : 6 (ISO100/m)	
Flash Coverage Range	28cm ~ 4.3m (at ISO Auto), 28cm ~ 3m (at ISO 200)	

Flash Mode	Forced Flash, Red-Eye Reduction Flash, Slow Synchro Mode
External Flash Sync.	Hotshoe (X Sync. Contact)
Drive Modes	Single, Continuous (3 frames/RAW) (4 frames/JPEG) Self Timer (2sec. /10sec.)
LCD Monitor	approx. 230,000 pixels, 2.5 inches TFT color LCD monitor
LCD Monitor Language	English / Japanese / German / Chinese (Simplified) / French Spanish / Italian / Korean / Russian
Interface	USB (USB2.0), Video Out (NTSC/PAL), Audio Out (Monaural)
Power	Li-ion Battery BP-31, AC Adapter SAC-3 (Optional)
Battery Life	Approx. 250 (+25°C)
Dimensions	113.3mm/4.5" (W) × 59.5mm /2.3"(H) ×56.06mm/2.2" (D)
Weight	260g / 9.2oz (without battery and card)

CONNECTING YOUR CAMERA TO A COMPUTER

The DP2 camera can be connected directly to a computer using the provided USB cable. Make sure that the camera is off before connecting it to the computer. Data transfer rates will vary depending on the computer and operating system used. For further information, please refer to the SIGMA Photo Pro User Guide, which is available in PDF format on the supplied CD-ROM.

CONNECTING THE CABLES

- Please confirm that [**USB Mode**] is set to [**Mass Storage**] in the [**Camera Settings**] menu before connecting your camera to a PC with supplied USB cable.
- The shutter button and color LCD monitor will be disabled while the camera is connected to the computer via a USB cable.

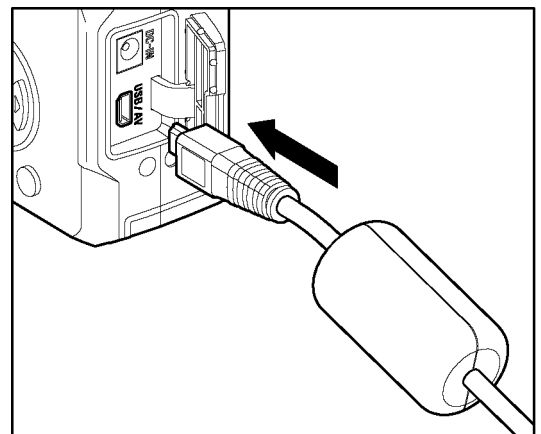

WARNING!!

- Please use only the USB cable supplied with your camera.

This device complies with Part 15 of the FCC Rules. Operation is subject to the following two conditions:
(1) This device may not cause harmful interference, and
(2) this device must accept any interference received, including interference that may cause undesired operation.

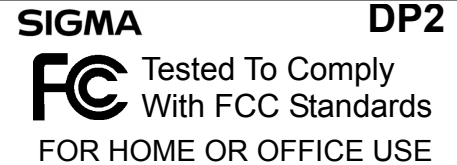

SIGMA CORPORATION OF AMERICA
15 Fleetwood Court, Ronkonkoma,
NY 11779, U.S.A.
TEL: 631 585 1144

For customers in the U.S.A.

Federal Communications Commission (FCC) Radio Frequency Interference Statement

This equipment has been tested and found to comply with the limits for class B digital devices, pursuant to Part 15 of the FCC Rules. These limits are designed to provide reasonable protection against harmful interference in a residential installation. This equipment generates, uses and can radiate radio frequency energy and, if not installed and used in accordance with the instructions, may cause harmful interference to radio communications. However, there is no guarantee that interference will not occur in a particular installation. If this equipment does cause harmful interference to radio or television reception, which can be determined by turning the equipment off and on, the user is encouraged to try to correct the interference by one or more of the following measures:

- Reorient or relocate the receiving antenna.
- Increase the separation between the equipment and receiver.
- Connect the equipment into an outlet on a circuit different from that to which the receiver is connected.
- Consult the dealer or an experienced radio/TV technician for help.

Use of interface cable is required to comply with class B limits in Subpart B of Part 15 of FCC Rules.

Any changes or modifications to this equipment not specified in this manual may void your warranty.

For customers in the Canada

This Class B digital apparatus complies with Canadian ICES-003.

Cet appareil numérique de la classe B est conforme à la norme NMB-003 du Canada.



The CE Mark is a Directive conformity mark of the European Community (EC).

SIGMA (Deutschland) GmbH

Carl-Zeiss-Str. 10/2, D-63322 Roedermark, Germany

Verkauf: 01805-90 90 85-0 Service: 01805-90 90 85-85 Fax(Service): 01805-90 90 85-35

SIGMA CORPORATION

2-4-16 Kuriki, Asao-ku, Kawasaki-shi, Kanagawa 215-8530 Japan

Phone : 044 - 989 - 7430 Fax : 044 - 989 - 7451